

<meta name='Description' content='Suitable for signal processing of potential-free outputs, e.g. emergency stop command devices, position switches and solenoid interlocks,Suitable for signal processing of outputs connected to potentials (AOPDs), e.g. safety light grids/curtains,3 safety contacts, STOP 0; 2 safety contacts, STOP 1 (adjustable 1 ... 30 s),4 Signalling outputs,Optional: Short-circuit recognition, Manual reset with edge detection in fail-safe circuit, Automatic reset function' />

06.07.2017

-
13:47:34h

Datasheet - SRB324ST 24V (V.3)



Guard door monitors and Safety control modules for Emergency Stop applications / General Purpose safety controllers (Series PROTECT SRB) / SRB324ST

Preferred typ



- Suitable for signal processing of potential-free outputs, e.g. emergency stop command devices, position switches and solenoid interlocks
- Suitable for signal processing of outputs connected to potentials (AOPDs), e.g. safety light grids/curtains
- 3 safety contacts, STOP 0;
2 safety contacts, STOP 1 (adjustable 1 ... 30 s)
- 4 Signalling outputs
- Optional: Short-circuit recognition, Manual reset with edge detection in fail-safe circuit, Automatic reset function

(Minor differences between the printed image and the original product may exist!)

Ordering details

Product type description	SRB324ST 24V (V.3)
Article number	101195504
EAN code	4030661446547
Replaced article number	101179876
eCl@ss	27-37-19-01

Approval

Approval



Classification

Standards

EN ISO 13849-1, IEC 61508, EN 60947-5-1

PL	up e (STOP 0) bis d (STOP 1)																		
Control category	up 4 (STOP 0) bis 3 (STOP 1)																		
DC	99% (STOP 0) > 60% (STOP 1)																		
CCF	> 65 points																		
PFH value	≤ 2,0 x 10 ⁻⁸ /h (STOP 0) ≤ 2,0 x 10 ⁻⁷ /h (STOP 1)																		
SIL	up 3 (STOP 0) bis 2 (STOP 1)																		
Mission time	20 Years																		
- notice	The PFH value is applicable for the combinations listed in the table for contact load (K) (current through enabling paths) and switching cycle number (n-op/y). In case of 365 operating days per year and a 24-hour operation, this results in the specified switching cycle times (t-cycle) for the relay contacts. Diverging applications on request.																		
	<table border="1"> <thead> <tr> <th>K</th> <th>n-op/y</th> <th>t-cycle</th> </tr> </thead> <tbody> <tr> <td>20 %</td> <td>525.800</td> <td>1,0 min</td> </tr> <tr> <td>40 %</td> <td>210.240</td> <td>2,5 min</td> </tr> <tr> <td>60 %</td> <td>75.087</td> <td>7,0 min</td> </tr> <tr> <td>80 %</td> <td>30.918</td> <td>17,0 min</td> </tr> <tr> <td>100 %</td> <td>12.223</td> <td>43,0 min</td> </tr> </tbody> </table>	K	n-op/y	t-cycle	20 %	525.800	1,0 min	40 %	210.240	2,5 min	60 %	75.087	7,0 min	80 %	30.918	17,0 min	100 %	12.223	43,0 min
K	n-op/y	t-cycle																	
20 %	525.800	1,0 min																	
40 %	210.240	2,5 min																	
60 %	75.087	7,0 min																	
80 %	30.918	17,0 min																	
100 %	12.223	43,0 min																	

Global Properties

Product name	SRB324ST
Standards	IEC/EN 60204-1, EN 60947-5-1, EN ISO 13849-1, IEC 61508
Compliance with the Directives (Y/N) 	Yes
Climatic stress	EN 60068-2-78
Mounting	snaps onto standard DIN rail to EN 60715
Terminal designations	IEC/EN 60947-1
Materials	
- Material of the housings	Plastic, glass-fibre reinforced thermoplastic, ventilated
- Material of the contacts	, Ag-Ni, self-cleaning, positive action
Weight	435 g
Start conditions	Automatic or Start button (Optional monitored)
Start input (Y/N)	Yes
Feedback circuit (Y/N)	Yes
Start-up test (Y/N)	No
Automatic reset function (Y/N)	Yes
Reset with edge detection (Y/N)	Yes
Pull-in delay	
- ON delay with automatic start	250 ms
- ON delay with reset button	20 ms
Drop-out delay	
- Drop-out delay in case of power failure	80 ms
- Drop-out delay in case of emergency stop	30 ms / ≤ 36 ms

Mechanical data

Connection type	Screw connection
Cable section	
- Min. Cable section	0,25 mm ²
- Max. Cable section	2.5 mm ²
Pre-wired cable	rigid or flexible
Tightening torque for the terminals	0,6 Nm

Detachable terminals (Y/N)	Yes
Mechanical life	10.000.000 operations
Electrical lifetime	Derating curve available on request
Resistance to shock	30 g / 11 ms
Resistance to vibration To EN 60068-2-6	10...55 Hz, Amplitude 0,35 mm

Ambient conditions

Ambient temperature	
- Min. environmental temperature	-25 °C
- Max. environmental temperature	+60 °C
Storage and transport temperature	
- Min. Storage and transport temperature	-40 °C
- Max. Storage and transport temperature	+85 °C
Protection class	
- Protection class-Enclosure	IP40
- Protection class-Terminals	IP20
- Protection class-Clearance	IP54
Air clearances and creepage distances To IEC/EN 60664-1	
- Rated impulse withstand voltage U_{imp}	4 kV
- Overvoltage category	III To VDE 0110
- Degree of pollution	2 To VDE 0110

Electromagnetic compatibility (EMC)

EMC rating	conforming to EMC Directive
------------	-----------------------------

Electrical data

Rated DC voltage for controls	
- Min. rated DC voltage for controls	20.4 V
- Max. rated DC voltage for controls	28.8 V
Rated AC voltage for controls, 50 Hz	
- Min. rated AC voltage for controls, 50 Hz	20.4 V
- Max. rated AC voltage for controls, 50 Hz	26.4 V
Rated AC voltage for controls, 60 Hz	
- Min. rated AC voltage for controls, 60 Hz	20.4 V
- Max. rated AC voltage for controls, 60 Hz	26.4 V
Contact resistance	max. 100 mΩ
Power consumption	3.2 W; 7.1 VA, plus signalling output
Type of actuation	AC/DC
Rated operating voltage U_e	24 VDC -15% / +20%, residual ripple max. 10% 24 VAC -15% / +10%
Operating current I_e	
Frequency range	50 Hz / 60 Hz
Electronic protection (Y/N)	Yes
Fuse rating for the operating voltage	Internal electronic trip, tripping current F1: > 2.5 A; F2 > 50 mA (S11 - S31), > 800 mA (x 4); Reset after disconnection of supply voltage
Current and tension on control circuits	
- S11, S12, S21, S22, S31, S32	24 VDC, Test current: 10 mA
- X1, X2	24 VDC, Start pulse: 350 mA / 15 ms
- X3, X4	24 VDC, Start pulse: 130 mA / 80 ms
- X4, X5	24 VDC, Start pulse: 140 mA / 15 ms

Bridging in case of voltage drops

70 ms

Inputs

Monitored inputs

- Short-circuit recognition (Y/N)	optional
- Wire breakage detection (Y/N)	Yes
- Earth connection detection (Y/N)	Yes
Number of shutters	0 piece
Number of openers	2 piece
Cable length	1-channel without cross-wire detection: 850 m with 1.5 mm ² 1400 m with 2.5 mm ² 2-channel with/ without cross-wire detection
Conduction resistance	max. 40 Ω

Outputs

- Stop category 1	Residual current at ambient temperature up to: - 45°C = 12 A; - 55°C = 10 A; - 60°C = 8 A
Stop category	0 / 1
- Stop category 0	Residual current at ambient temperature up to: - 45°C = 18 A; - 55°C = 15 A; - 60°C = 12 A
Number of safety contacts	5 piece
Number of auxiliary contacts	1 piece
Number of signalling outputs	3 piece
Switching capacity	
- Switching capacity of the safety contacts	(13-14; 23-24; 33-34) max. 250 V, 8 A ohmic (inductive in case of appropriate protective wiring) (47-48; 57-58) max. 250 V, 6 A ohmic (inductive in case of appropriate protective wiring)
- Switching capacity of the auxiliary contacts	61-62: 24 VDC / 2 A
- Switching capacity of the signaling/diagnostic outputs	Y1-Y3: 24 VDC / 100 mA, residual current: 200 mA
Fuse rating	
- Protection of the safety contacts	8 A slow blow (13-14; 23-24) 6.3 A slow blow (37-38)
- Fuse rating for the auxiliary contacts	2 A slow blow
- Fuse rating for the signaling/diagnostic outputs	500 mA (Internal electronic trip F3)
Utilisation category To EN 60947-5-1	13-14, 23-24, 33-34: AC-15: 230 V / 6 A, DC-13: 24 V / 6 A 37-38, 47-48: AC-15: 230 V / 3 A, DC-13: 24 V / 2 A
Note on the utilisation category	
Number of undelayed semi-conductor outputs with signaling function	3 piece
Number of undelayed outputs with signaling function (with contact)	1 piece
Number of delayed semi-conductor outputs with signaling function.	0 piece
Number of delayed outputs with signalling function (with contact).	0 piece
Number of secure undelayed semi-conductor outputs with signaling function	0 piece
Number of secure, undelayed outputs with signaling function, with contact.	3 piece
Number of secure, delayed semi-conductor outputs with signaling function	0 piece
Number of secure, delayed outputs with signaling function (with contact).	2 piece

LED switching conditions display

LED switching conditions display (Y/N)

Yes

Number of LED's 6 piece

LED switching conditions display

- The integrated LEDs indicate the following operating states.
- Position relay K2
- Position relay K3
- Position relay K1
- Position relay K4
- Supply voltage
- Internal operating voltage U_i

Miscellaneous data

Applications



Guard system



Emergency-Stop button



Pull-wire emergency stop switches



Safety light curtain



Safety sensor

Dimensions

Dimensions

- Width 45 mm
- Height 100 mm
- Depth 121 mm

notice

Inductive loads (e.g. contactors, relays, etc.) are to be suppressed by means of a suitable circuit.

notice - Wiring example

2 channel control shown for a guard-door monitor with two contacts, of which at least one contact has positive break, with external reset button (R).

Relay outputs: Suitable for 2 channel control, for increase in capacity or number of contacts by means of contactors or relays with positive-guided contacts.

(H2) = Feedback circuit

The control recognises cross-short, cable break and earth leakages in the monitoring circuit.

The wiring diagram is shown with guard doors closed and in de-energised condition.

Documents

Operating instructions and Declaration of conformity (pt) 622 kB, 07.10.2016

Code: mrl_srb_324st_v3_pt

Operating instructions and Declaration of conformity (es) 620 kB, 07.10.2016

Code: mrl_srb_324st_v3_es

Operating instructions and Declaration of conformity (jp) 867 kB, 20.01.2017

Code: mrl_srb_324st_v3_jp

Operating instructions and Declaration of conformity (pl) 612 kB, 11.01.2017

Code: mrl_srb_324st_v3_pl

Operating instructions and Declaration of conformity (cn) 770 kB, 13.07.2015

Code: mrl_srb_324st_v3_cn

Operating instructions and Declaration of conformity (de) 674 kB, 09.09.2016

Code: mrl_srb_324st_v3_de

Operating instructions and Declaration of conformity (da) 592 kB, 13.10.2015

Code: mrl_srb_324st_v3_da

Operating instructions and Declaration of conformity (fr) 621 kB, 07.10.2016

Code: mrl_srb_324st_v3_fr

Operating instructions and Declaration of conformity (en) 682 kB, 09.09.2016

Code: mrl_srb_324st_v3_en

Operating instructions and Declaration of conformity (it) 618 kB, 07.10.2016

Code: mrl_srb_324st_v3_it

Operating instructions and Declaration of conformity (it) 1 MB, 03.01.2012

Code: mrl_srb_324st_v3_it

Operating instructions and Declaration of conformity (nl) 620 kB, 07.10.2016

Code: mrl_srb_324st_V3_nl

Wiring example (99) 21 kB, 04.08.2008

Code: ksr3l10

TÜV certification (de, en) 226 kB, 04.09.2012

Code: z_srbp02

Images

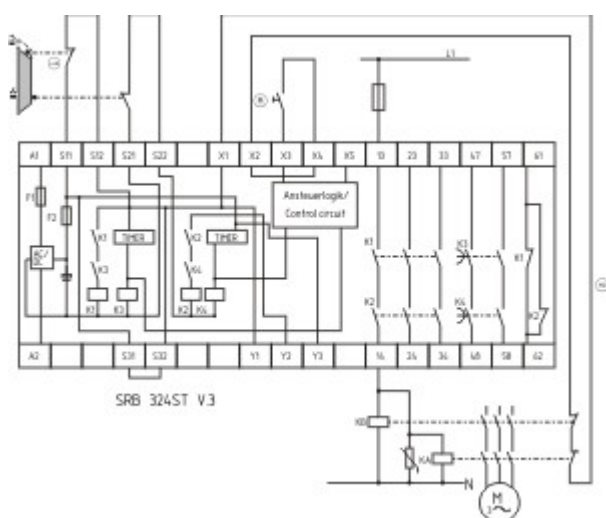

Wiring example

K.A. Schmersal GmbH & Co. KG, Möddinghofe 30, D-42279 Wuppertal

The data and values have been checked thoroughly. Technical modifications and errors excepted.

Generiert am 06.07.2017 - 13:47:34h Kasbase 3.2.7.F.64l