

– weishaupt –

# product

Information on oil, gas and dual fuel burners



WM 30 oil, gas and dual fuel version

Weishaupt monarch® WM30 burners • highly efficient and versatile

# Advanced technology starts from tradition

## The new monarch<sup>®</sup> burner



*The Monarch<sup>®</sup> Trademark has represented performance and quality in burner industry for over 50 years*

For over five decades, Weishaupt monarch<sup>®</sup> series burners have been used at various heating and industrial process applications. Over this period of time, they have built an excellent reputation for Weishaupt.

With the new monarch<sup>®</sup> WM burner this success story is now continued. Ultra modern technology in conjunction with a compact design allows this high performance burner to be universally utilized in various applications.

## Digital.

Digital combustion management system ensures economical and safe burner operation. The operation is simple.

## Compact.

The streamlined shape of the burner casing and the specially designed air intake make it possible to achieve high capacity with compact size.

## Quiet.

Thanks to the newly designed blower unit, the new monarch<sup>®</sup> burners operate with lower sound levels.



# Digital

## Digital combustion management means optimum combustion results, always repeatable operating points and easy handling.

Weishaupt WM 30 series oil, gas and dual fuel burners are equipped with electronic fuel air ratio controller and digital combustion manager as standard. Modern heating applications require precise and always repeatable correct mixture of fuel and air. Only this way, optimum combustion values can be guaranteed over extended periods of time.

### Simple operation

The programming of burner function is performed via the Display and Control unit. The unit is connected to the combustion manager via a BUS system.

## Flexible communication possibilities

The integrated interface makes it possible to receive and send all required information and control commands from and to the BMS system. If required, a modem can be installed so that remote monitoring and remote diagnostic function can be activated.

### Communication with remote control system or with BMS system

The system supports several communication protocols for connecting to BMS system if data has to be exchanged between burners and other heating systems with PLC devices.

For control and management functions, Weishaupt offers ProGraf NT – a software product that provides real time solution to meet all requirements.

## Advantages of new technology

Digital combustion management makes burner operation user friendly and safe. The most important benefits are:

- No additional burner controls are required since this function is already taken care by the combustion manager. Fuses and eventually mains dis-connect switch are the only additional items required.
- Less installation work means less errors: the burners are tested as a complete unit at the factory.
- Commissioning and service work take less time. The initial presetting of the burner is carried out at the factory. On site, only the site specific operating points have to be adjusted.

System overview Digital Combustion Management	W-FM50	W-FM54	W-FM 100	W-FM 200
Combustion manager for intermittent operation	●	●	●	●
Combustion manager for continuous operation	● <sup>2)</sup>		●	●
Flame sensor for intermittent operation	ION/QRA2/QRB	QRA2	ION/QRI/QRB	ION/QRI/QRB
Flame sensor for continuous operation	ION		ION/QRI/QRA73	ION/QRI/QRA73
Number of actuator (max.)	2 pcs	3 pcs	4 pcs	6 pcs
Actuator with stepping motor	●	●	●	●
Compatible with Variable Speed Drive operation	●	●		●
O <sub>2</sub> -Trim (optional)				●
Single fuel operation	●		●	●
Dual fuel operation		●	●	●
Valve proving system for gas valves	●	●	●	●
Integrated self tuning PID-Modulating controller for Temperature or Pressure			●	●
Removable ABE control unit (max. distance)	65 ft (20 m)	65 ft (20 m)	325 ft (100 m)	325 ft (100 m)
Fuel meter interface	● <sup>1)</sup>	● <sup>1)</sup>		●
Combustion efficiency display (w/ optional sensor)				●
eBUS / MOD BUS interface	●	●	●	●
PC interface	●	●	●	●

<sup>1)</sup> Not in conjunction with VFD operation

<sup>2)</sup> Gas operation only in conjunction with flamerod

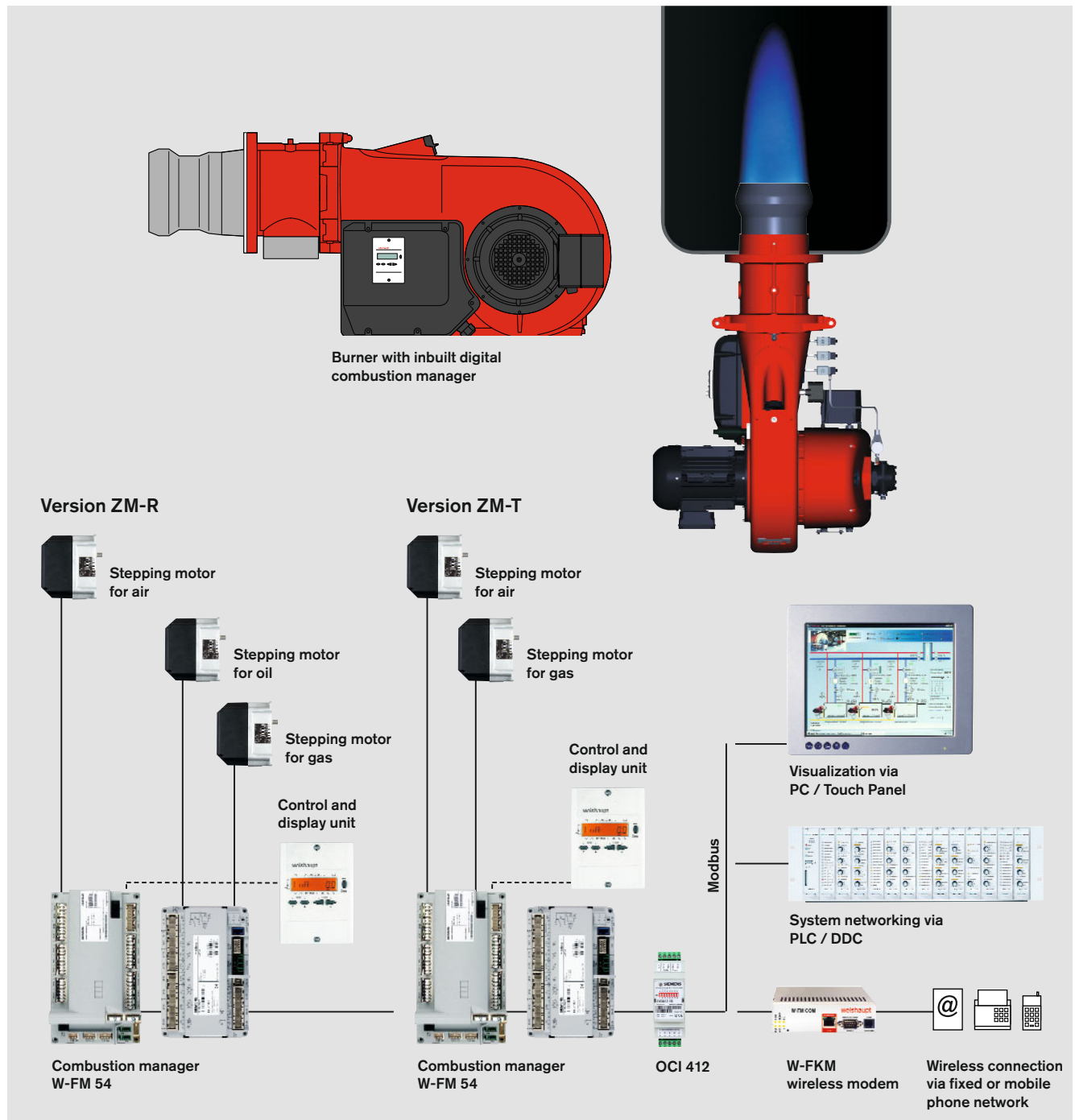

Connection schematic with W-FM 54

# Compact and Quiet

**The newly developed Weishaupt monarch® WM 30 burner is compact, efficient and quiet. It is the continuation of the 50 years success history of the legendary monarch® series.**

## **Advanced blower fan technology**

Right from early development phase of this new burner generation, future oriented blower fan technology has been utilized to achieve a compact, streamlined design and low operating noise.

## **Innovative air damper control**

The newly developed air damper control provides a high degree of linearity over the entire operating range.

## **Reduced noise level**

Right from the earliest developmental stage of this new burner generation, particular emphasis was placed on low operational noise level.

## **Quick commissioning, easy maintenance**

All WM 30 burners are shipped out with an adjustable mixing head. Final adjustment is to be performed via commissioning program in the combustion manager.

Despite its compact design all components such as oil nozzles, mixing head, air damper and combustion manager are easily accessible. Therefore maintenance and service work can be performed easily and quickly. The standard hinged flange allows ideal service position for the burner.

Matching to various combustion chamber geometries can be performed directly on the burner. The flame and the ignition process can be observed via the integrated viewing port.

## **Flexible control capability**

WM 30 burners are available with the following control options:

Oil: 3-stage (T)  
modulating (R)  
Gas: Sliding two stage or  
modulating (ZM)

This allows flexible control possibilities, which make the burner universally adaptable to various applications. Both versions result in a smooth, trouble free start and reliable operation.

## **Various versions are available to meet different emission and operation requirements:**

### **ZM version**

Standard version for gas and dual fuel burners.

### **LN (LowNOx) version**

Low NOx version of WM gas burners. The low NOx emission is achieved by increased recirculation of combustion gases.

Compliance to certain emission requirement is also dependant on combustion chamber geometry, volume loading and design of the combustion system.

### **3LN multiflam® version**

Low NOx - Oil/ Gas/ Dual fuel burner equipped with multiflam mixing head for the most stringent emission requirements. The low NOx emission is achieved by fuel distribution principle.

### **Suitable fuels**

Natural gas  
Propane  
Light Oil #2 according to ASTM D396

Different type of fuel requires written confirmation from Weishaupt.

## **Applications**

Weishaupt WM 30 oil, gas and dual fuel burners are suitable to be used for the following:

- Installation on heat exchanger
- Hot water boiler
- Steam boiler and high pressure hot water boiler
- Intermittent and continuous operation
- Hot air generator

The combustion air must be free from any aggressive substances (Halogen, Chloride, Fluoride, etc) and contamination (dust, building materials, vapours, etc). For many cases an external air ducting to the burner is recommended as an option.

## **Permissible ambient conditions:**

- Ambient temperature  
-10 to +40 °C (14 to 104F)  
-15 to +40 °C (5 to 104F)
- Air humidity: max. 80 % relative humidity, no condensation
- Suitable only for indoor operation
- For installation in unheated rooms under some circumstances special solutions are required (contact Weishaupt)

Any discrepancy from the above described applications requires written confirmation from Weishaupt Corporation. The maintenance interval could be shortened according to conditions where the burners are installed.

## **Approvals**

WM 30 series burners are in compliance with most European and North American applicable standards.

**The most important advantages at a glance:**

- Digital combustion management with electronic fuel air ratio controller
- Quiet operation due to air inlet equipped with sound absorbing material as standard
- High performance blower due to specially designed blower geometry and air damper control system
- All WM 30 burners are equipped with adjustable flame tube to match required firing rate
- Protection class IP 54 as standard
- Easy access to all components, such as: mixing head, air damper and combustion manager
- Safe operation with sliding two stage/ modulating operation as standard depending on type of modulating controller
- Computer aided function test of each individual burner in factory
- Excellent price to performance ratio
- Worldwide service network

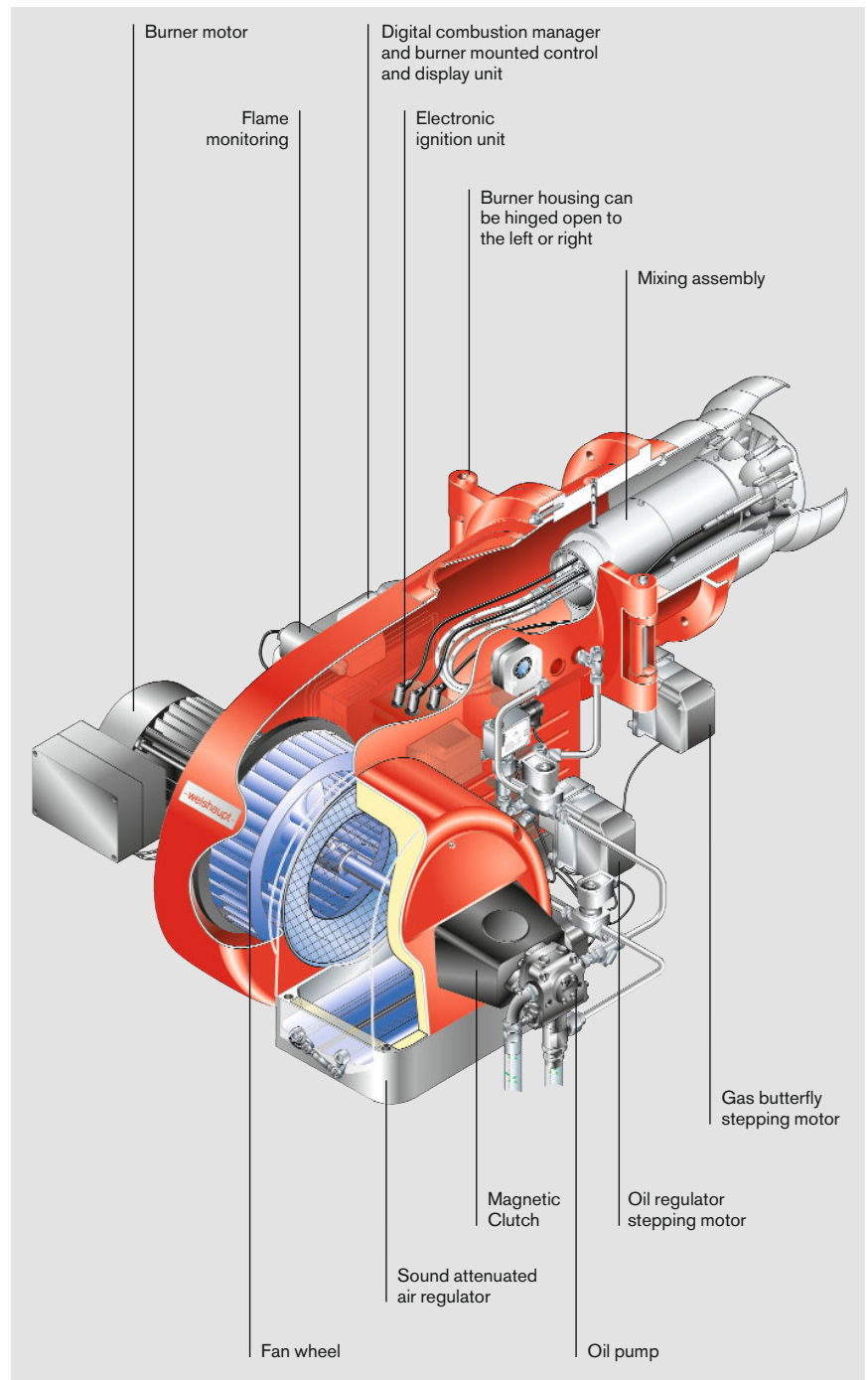

WM-GL30 version ZM-R

# Overview of operating modes

## Burner's nomenclature

### Operation with oil

#### 3 stage (T) operation

- Oil release during start by opening the solenoid valve 1 and safety solenoid valve
- Highfire is achieved by opening solenoid valves 2 and 3
- Firing rate is controlled by opening and closing solenoid valves 2 and 3

#### Modulating (R) operation

- By opening the solenoid valve, oil amount required for ignition is released
- A digital stepping motor regulates the oil regulator up to full capacity
- Burner firing rate between low and highfire is controlled by opening and closing oil regulator
- Integrated or external modulating controller can be used as firing rate controller.

#### 3-stage

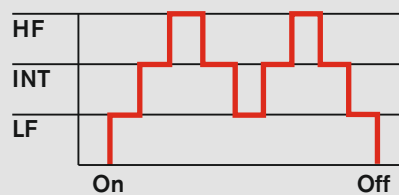

#### sliding stage

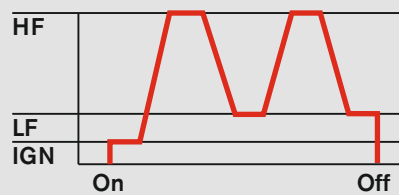

#### modulating

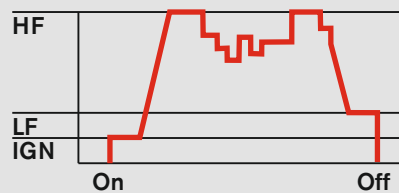

### Operation with gas

#### Sliding stage or modulating (ZM) operation

- Burner capacity between low and highfire depending on heat requirement is controlled by stepping motor
- Anywhere between both operating points the burner can be operated. There are no sudden changes of fuel flow
- Option for combustion manager:
  - W-FM 50 (single fuel application) with additional modulating controller
  - W-FM 54 (dual fuel application) with additional modulating controller
  - W-FM 100 (single/ dual fuel) with integrated modulating controller
  - W-FM 200 (single/dual fuel)
- Alternatively an external modulating controller can also be used for that purpose.

HF = Highfire  
 INT = Intermediary fire  
 LF = Lowfire  
 IGN = Ignition

Fuel Version	Oil			Gas	
	3-stage	sliding-stage	modulating	sliding-stage	modulating
ZM				●	●
ZM-T	●			●	●
ZM-R		●	●	●	●

### Nomenclature

WM - GL 30 / 3 -A / ZM - T  
 ZM - R

Version  
 T = 3-stage  
 R = sliding stage or modulating

Size  
 Capacity  
 Revision

G = Gas  
 L = #2 Oil

Weishaupt monarch® burner series



# Burner selection WM 30 Oil burners vers. T and R

**Burner model** WM-L30/1-A/ T and /R  
Combustion head WM-L30/1, 222K x 45  
Capacity MBTU/h #2 Oil 2,730 – 10,580

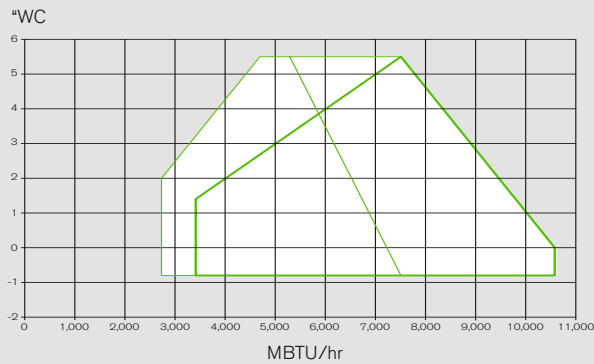

**Burner model** WM-L30/2-A/ T and /R  
Combustion head WM-L30/2, 222K x 45  
Capacity MBTU/h #2 Oil 3,070 – 13,995

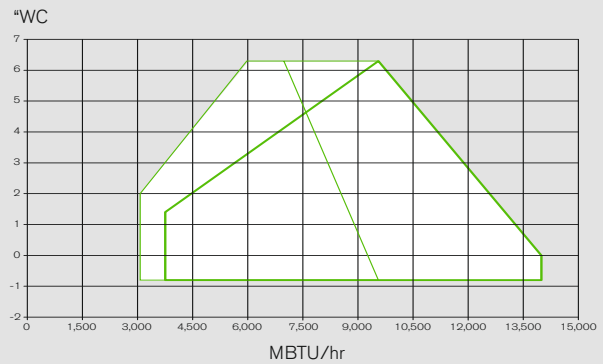

**Burner model** WM-L30/3-A/ R  
Combustion head WM-L30/3, 257K x 62  
Capacity MBTU/h #2 Oil 3,750 – 19,450

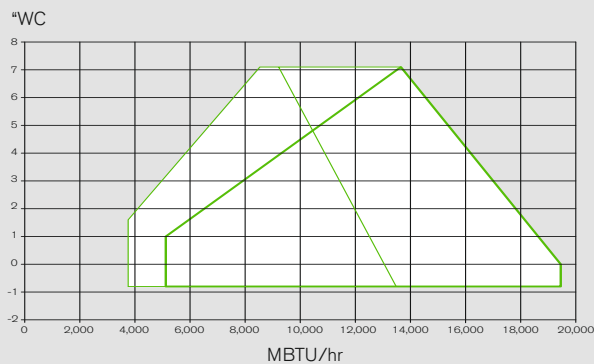

#2 oil with flame tube  
close —  
open —

The firing rates are based on an installation altitude of 1,640 ft (500 m). A reduction of burner capacity of 1 % for every 325 ft (100 m) should be taken into consideration in case of installation altitude above 0 ft.

Voltages and frequencies:  
The burners are equipped with three phase motor in 208 - 600 V, 60 Hz as standard. Different voltage and frequency are available upon request.

Standard burner motor:  
Insulation class F, protection IP 54.

## Burner order numbers

Burner model	Version	Order No.
WM-L30/1-A	T	211 320 10
WM-L30/2-A	T	211 320 20

Burner model	Version	Order No.
WM-L30/1-A	R	215 320 10
WM-L30/2-A	R	215 320 20
WM-L30/3-A	R	215 320 30

# Burner selection WM G30

## Gas and dual fuel burners vers. ZM-T and ZM-R

**Burner model** WM-G30/1-A ZM  
**WM-GL30/1-A ZM-T and ZM-R**  
 Combustion head WM-G(L)30/1, 222K x 45  
 Capacity MBTU/h Natural gas 1,195 – 10,580  
 Propane 1,700 – 10,580  
 #2 Oil 2,730 – 10,580

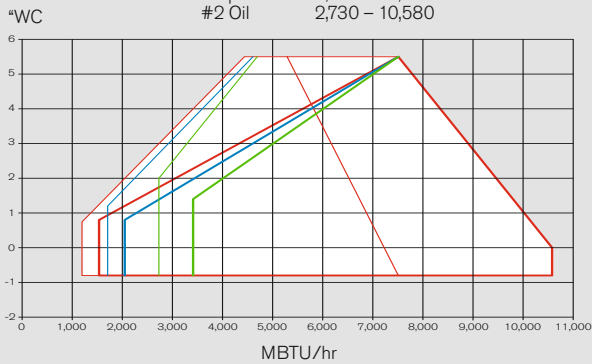

**Burner model** WM-G30/2-A ZM  
**WM-GL30/2-A ZM-T and ZM-R**  
 Combustion head WM-G(L)30/2, 222K x 45  
 Capacity MBTU/h Natural gas 1,535 – 13,995  
 Propane 2,050 – 13,995  
 #2 Oil 3,070 – 13,995

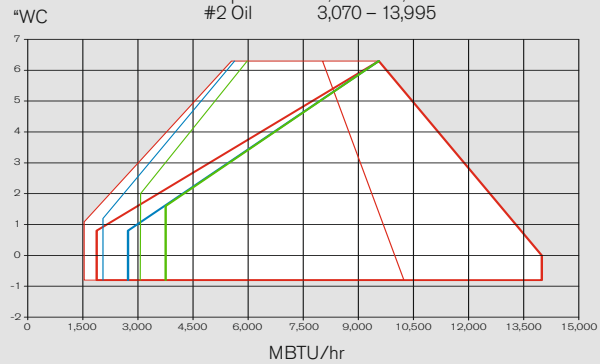

**Burner model** WM-G30/3-A ZM  
**WM-GL30/3-A ZM-R**  
 Combustion head WM-G(L)30/3, 260K x 62  
 Capacity MBTU/h Natural gas 2,050 – 19,450  
 Propane 3,070 – 19,450  
 #2 Oil 3,750 – 19,450

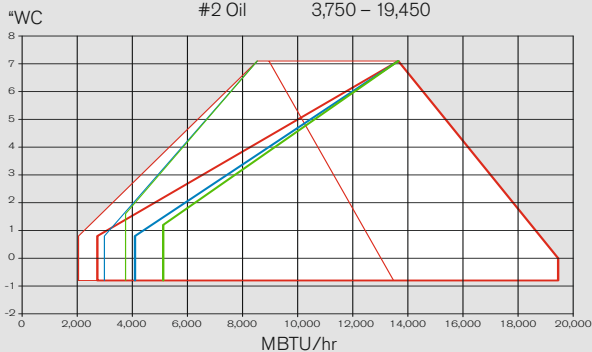

**Natural gas with flame tube**  
 close ———  
 open ———

**Propane with flame tube**  
 close ———  
 open ———

**#2 Oil with flame tube**  
 close ———  
 open ———

The firing rates are based on an installation altitude of 0 ft (0 m). A reduction of burner capacity of 1 % for every 325 ft (100 m) should be taken into consideration in case of installation altitude above 0 ft.

Voltages and frequencies:

The burners are equipped with three phase motor in 208 - 600 V, 60 Hz as standard. Different voltage and frequency are available upon request.

Standard burner motor:

Insulation class F, protection IP 54.

### Burner order numbers

Burner model	Version	Order No.
WM-G30/1-A	ZM	217 310 13
WM-G30/2-A	ZM	217 312 11
WM-G30/3-A	ZM	217 314 12

Burner model	Version	Order No.
WM-GL30/1-A	ZM-T	218 310 11
WM-GL30/2-A	ZM-T	218 311 11
WM-GL30/1-A	ZM-R	218 315 11
WM-GL30/2-A	ZM-R	218 316 11
WM-GL30/3-A	ZM-R	218 317 12

# Burner selection WM G30

## Gas burners vers. ZM-LN

**Burner model** WM-G30/1-A ZM-LN  
 Combustion head WM-G30/1 LN, 210 x 60  
 Capacity MBTU/h Natural gas 1,195 – 9,550  
 Propane 1,700 – 9,550

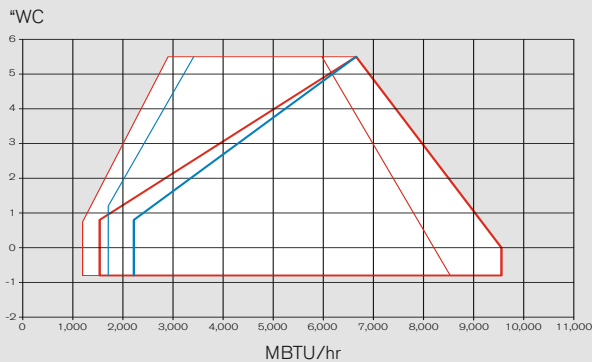

**Burner model** WM-G30/2-A ZM-LN  
 Combustion head WM-G30/2 LN, 210 x 60  
 Capacity MBTU/h Natural gas 1,365 – 12,970  
 Propane 1,700 – 12,970

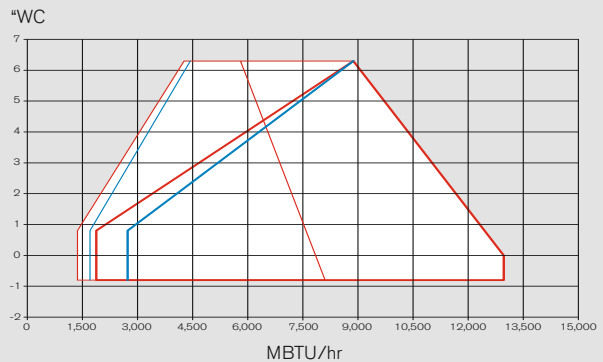

**Burner model** WM-G30/3-A ZM-LN  
 Combustion head WM-G30/3 LN, 250 x 90  
 Capacity MBTU/h Natural gas 2,050 – 18,430  
 Propane 2,730 – 18,430

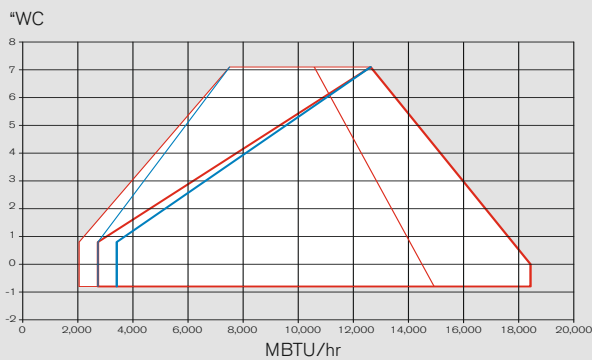

**Natural gas with flame tube**      **Propane with flame tube**  
 close ————                              close ————  
 open ————                                open ————

The firing rates are based on an installation altitude of 0 ft (0 m). A reduction of burner capacity of 1 % for every 325 ft (100 m) should be taken into consideration in case of installation altitude above 0 ft.

Voltages and frequencies:  
 The burners are equipped with three phase motor in 208 - 600 V, 60 Hz as standard. Different voltage and frequency are available upon request.

Standard burner motor:  
 Insulation class F, protection IP 54.

### Burner order numbers

Burner model	Version	Order No.
WM-G30/1-A	ZM-LN	217 311 11
WM-G30/2-A	ZM-LN	217 313 11
WM-G30/3-A	ZM-LN	217 315 12

# Standard scope of supply

Description	WM-L30-T	WM-L30-R	WM-G30 ZM/LN	WM-GL30 ZM-T	WM-GL30 ZM-R
Burner housing, Hinge flange, housing cover, Weishaupt burner motor, air intake housing, fan wheel, combustion head, ignition unit, ignition cable, ignition electrodes, combustion manager with operating unit, flame sensor, stepping motors, flange gasket, limit switch on hinge flange, fixing screws	●	●	●	●	●
Digital combustion manager W-FM 50 W-FM 54	● -	● -	● -	- ●	- ●
Two gas safety shut off valves	-	-	●	●	●
Gas butterfly valve	-	-	●	●	●
Air pressure switch	-	-	●	●	●
Adjustable flame tube	●	●	●	●	●
Stepping motor for fuel/air compound regulation with W-FM:					
Stepping motor for air damper	●	●	●	●	●
Stepping motor for gas butterfly valve	-	-	●	●	●
Stepping motor for oil regulator	-	●	-	-	●
Oil pressure switch in return	-	●	-	-	●
Burner mounted oil pump	●	●	-	●	●
Oil hoses	●	●	-	●	●
2 oil solenoid valves, oil regulator, nozzle head with nozzle solenoid, premounted spill type nozzle and safety shut off device	-	●	-	-	●
3 oil solenoid valves, 1 safety valve, three stage nozzle head with premounted oil nozzle	●	-	-	●	-
Magnetic clutch	○	○	-	●	●
IP 54 protection	●	●	●	●	●

● Standard  
○ Optional

# Special equipment

## Oil burners WM-L 30 vers. T and R

Special equipment version T		WM-L30/1-A / T	WM-L30/2-A / T	
Combustion head extension	by 6" (150 mm)	210 031 03	210 031 03	
	by 12" (300 mm)	210 031 04	210 031 04	
Oil hoses 50" (1300 mm) in lieu of 39" (1000 mm)		on request	on request	
Connection for air intake duct		on request	on request	
Oil meter	VZ 020	210 031 14	210 031 14	
	VZ 020 with remote transmitter LF	210 031 13	210 031 13	
Solenoid valve for air pressure switch test, continuous run fan or post purge		250 030 21	250 030 21	
Modulating controller KS20 mounted on burner (W-FM50)		250 033 15	250 033 15	
W-FM 100 (suitable for continuous operation) in lieu of W-FM 50	fitted	210 030 32	210 030 32	
	loose	210 030 88	210 030 88	
W-FM 200 in lieu of W-FM 50 with built-in modulating controller, speed control module with optional fuel metering	fitted	210 030 10	210 030 10	
	loose	on request	on request	
Flame sensor QRI in lieu of QRB		210 030 24	210 030 24	
Special voltages		on request	on request	
Special equipment vers. R		WM-L30/1-A / R	WM-L30/2-A / R	WM-L30/3-A / R
Combustion head extension	by 6" (150 mm)	210 031 05	210 031 05	210 031 06
	by 12" (300 mm)	210 031 07	210 031 07	210 031 08
Oil hoses 50" (1300 mm) in lieu of 39" (1000 mm)		110 001 59	–	–
Connection for air intake duct		on request	on request	on request
Solenoid valve for air pressure switch test, continuous run fan or post purge		250 030 21	250 030 21	250 030 21
Modulating controller KS20 mounted on burner (W-FM50)		250 033 15	250 033 15	250 033 15
W-FM 100 (suitable for continuous operation) in lieu of W-FM 50	fitted	210 030 38	210 030 38	210 030 38
	loose	on request	on request	on request
W-FM 200 in lieu of W-FM 50 with built-in modulating controller, speed control module with optional fuel metering	fitted	210 030 39	210 030 39	210 030 39
	loose	on request	on request	on request
Flame sensor QRI in lieu of QRB		210 030 24	210 030 24	210 030 24
Speed control with burner motor mounted VFD (W-FM 50/200 required)		210 030 97	–	–
Speed control with separate VFD (W-FM 200 required)		210 030 98	210 030 98	210 031 00
Special voltages		on request	on request	on request

# Accessories

## Gas burners WM-G 30 vers. ZM and ZM-LN

<b>Accessories for version ZM</b>		<b>WM-G 30/1-A</b>	<b>WM-G 30/2-A</b>	<b>WM-G 30/3-A</b>
Combustion head extension	by 6" (150 mm)	on request	on request	on request
	by 12" (300 mm)	on request	on request	on request
Solenoid valve for air pressure switch test continuous run fan or post purge		250 030 21	250 030 21	250 030 21
Modulating controller KS20 mounted on burner (W-FM50)		250 033 15	250 033 15	250 033 15
Adapter for ducted air intake		on request	on request	on request
W-FM 100 (suitable for cont. operation) instead of W-FM 50	fitted	250 030 74	250 030 74	250 030 74
	loose	250 030 45	250 030 45	250 030 45
W-FM 200 instead of W-FM 50 with built in modulating controller and VFD control with optional fuel metering	fitted	250 030 75	250 030 75	250 030 75
	loose	250 030 48	250 030 48	250 030 48
Speed control with burner motor mounted VFD (W-FM 50/200 required)		on request	on request	–
Speed control with separate VFD (W-FM 50/200 required)		on request	on request	on request
Special voltages		on request	on request	on request
<b>Special equipment vers. ZM-LN</b>		<b>WM-G30/1-A</b>	<b>WM-G30/2-A</b>	<b>WM-G30/3-A</b>
Combustion head extension	by 6" (150 mm)	on request	on request	on request
	by 12" (300 mm)	on request	on request	on request
Solenoid valve for air pressure switch test for continuous run fan or post-purge		250 030 21	250 030 21	250 030 21
Modulating controller KS20 mounted on burner (W-FM50)		250 033 15	250 033 15	250 033 15
Adapter for ducted air intake		on request	on request	on request
W-FM 100 (suitable for cont. operation) in lieu of W-FM 50	fitted	250 030 74	250 030 74	250 030 74
	loose	250 032 32	250 032 32	250 032 32
W-FM 200 in lieu of W-FM 50 with built in modulating controller, speed control module and optional fuel metering	fitted	250 030 75	250 030 75	250 030 75
	loose	on request	on request	on request
Speed control with burner motor mounted VFD (W-FM 50 or 200 required)		210 030 97	210 030 97	–
Speed control with separate VFD (FC from accessories) (W-FM 200 required)		on request	on request	on request
Special voltages		on request	on request	on request

## Accessories

### Dual fuel burners WM-GL30 vers. ZM-T and ZM-R

Accessories for version ZM-T		WM-GL 30/1-A	WM-GL 30/2-A	
Combustion head extension	by 6" (150 mm)	250 031 87	250 031 87	
	by 12" (300 mm)	250 031 88	250 031 88	
Solenoid valve for air press. switch test - cont. run fan or post purge		250 030 21	250 030 21	
Adapter for ducted air intake		on request	on request	
W-FM 100 (suitable for cont. operation) inst. W-FM 54 with built in modulating controller	fitted	250 031 78	250 031 78	
	loose	on request	on request	
W-FM 200 instead of W-FM 54 with built in modulating controller and VFD control with optional fuel metering	fitted	250 031 77	250 031 77	
	loose	on request	on request	
Speed control with burner motor mounted VFD (W-FM 54/200 required)		on request	–	
Speed control with separate VFD (W-FM 54/200 required)		on request	on request	
Oil hoses 50" (1300) mm instead of 40" (1000 mm)		on request	on request	
Oil meter VZ20		on request	on request	
Oil meter VZ020 with remote transmitter LF		on request	on request	
Special voltages		on request	on request	
Accessories for version ZM-R		WM-GL 30/1-A	WM-GL 30/2-A	WM-GL 30/3-A
Combustion head extension	by 6" (150 mm)	250 031 89	250 031 89	250 031 91
	by 12" (300 mm)	250 031 90	250 031 90	250 031 92
Solenoid valve for air press. switch test - cont. run fan or post purge		250 030 21	250 030 21	250 030 21
Adapter for ducted air intake		on request	on request	on request
W-FM 100 (suitable for cont. operation) inst. W-FM 54 with built in modulating controller	fitted	250 031 78	250 031 78	250 031 78
	loose	on request	on request	on request
W-FM 200 instead of W-FM 54 with built in modulating controller and VFD control with optional fuel metering	fitted	250 031 77	250 031 77	250 031 77
	loose	on request	on request	on request
Speed control with burner motor mounted VFD (W-FM 54/200 required)		on request	–	–
Speed control with separate VFD (W-FM 54/200 required)		on request	on request	on request
Oil hoses 50" (1300) mm instead of 40" (1000 mm)		on request	on request	on request
Special voltages		on request	on request	on request

# Technical data

## Oil burners

Oil burners version T		WM-L30/1-A	WM-L30/2-A
Burner motor <sup>1)</sup>	Weishaupt model	WM-D 132/120-2/7K5	WM-D 132/170-2/10K0
Rated power	HP (kW)	10.6 (8.0)	16 (12)
Full load amps (FLA)	A (@460 V)	14	18
Motor fuse (YΔ start)	A	25 A slow (external)	35 A slow (external)
Speed (60 Hz)	rpm	3,500	3,520
Combustion manager	model	W-FM 50	W-FM 50
Air stepping motor	model	SQM33	SQM33
Weight	lbs (kg)	approx. 330 (150)	approx. 342 (155)
Oil pump	model	J7	TA2
maximum flow rate	GPH (l/h)	123 (474)	165 (636)
Oil hoses	DN/Length	1/2" / 40" (13/ 1000)	3/4" / 40" (20/ 1000)

Oil burners version R		WM-L30/1-A	WM-L30/2-A	WM-L30/3-A
Burner motor	Weishaupt model	WM-D 132/120-2/7K5	WM-D 132/170-2/10K0	WM-D 132/210-2/14K0
Rated power	HP (kW)	10.6 (8.0)	16 (12)	20 (15)
Full load amps (FLA)	A (@460 V)	14	18	25
Motor fuse (YΔ start)	A	25 A slow (external)	35 A slow (external)	50 A slow (external)
Speed (60 Hz)	rpm	3,500	3,520	3,520
Combustion manager	model	W-FM 50	W-FM 50	W-FM 50
Stepping motor Air/Oil	model	SQM 33	SQM 33	SQM 33
Weight	lbs (kg)	approx. 353 (160)	approx. 364 (165)	approx. 386 (175)
Oil pump	model	TA3	TA4	TA5
maximum flow rate	GPH (l/h)	244 (942)	327 (1260)	438 (1690)
Oil hoses	DN/ length	3/4" / 40" (20/ 1000)	1" / 50" (25/ 1300)	1" / 50" (25/ 1300)

### Voltages and frequencies:

The burners are equipped with three phase motor in 208 - 600 V, 60 Hz as standard. Different voltage and frequency are available upon request.

### Standard burner motor:

Insulation class F, protection IP 54.



# Technical data

## Gas and dual fuel burners

Gas burners version ZM		WM-G 30/1-A	WM-G 30/2-A	WM-G 30/3-A
Burner motor	Weishaupt model	WM-D 132/120-2/7K5	WM-D 132/170-2/10K0	WM-D 132/210-2/14K0
Rated power	HP (kW)	10.6 (8.0)	16 (12)	18.9 (14.2)
Full load amps (FLA)	A (@460 V)	14	18	26.5
Motor fuse (YΔ start)	A	25 A slow (external)	35 A slow (external)	50 A slow (external)
Speed (60 Hz)	rpm	3,500	3,520	3,500
Combustion manager	Model	W-FM 50	W-FM 50	W-FM 50
Air/Gas stepping motor	Model	SQM 33	SQM 33	SQM 33
Weight	lbs (kg)	approx. 362 (164)	approx. 395 (179)	approx. 395 (179)

Dual fuel burners version ZM-T		WM-GL 30/1-A	WM-GL 30/2-A
Burner motor	Weishaupt model	WM-D 132/120-2/7K5	WM-D 132/170-2/10K0
Rated power	HP (kW)	10.6 (8.0)	16 (12)
Full load amps (FLA)	A (@460 V)	14	18
Motor fuse (YΔ start)	A	25 A slow (external)	35 A slow (external)
Speed (60 Hz)	rpm	3,500	3,520
Combustion manager	Model	W-FM 54	W-FM 54
Air/Gas stepping motor	Model	SQM 33	SQM 33
Weight	lbs (kg)	approx. 384 (174)	approx. 395 (179)
Oil pump	model	J7	TA2
maximum flow rate	GPH (l/h)	123 (474)	165 (636)
Oil hoses	DN/ length	1/2" / 40" (13/ 1000)	3/4" / 40" (20/ 1000)

Dual fuel burners version ZM-T		WM-GL 30/1-A	WM-GL 30/2-A	WM-GL 30/3-A
Burner motor	Weishaupt model	WM-D 132/120-2/7K5	WM-D 132/170-2/10K0	WM-D 132/210-2/14K0
Rated power	HP (kW)	10.6 (8.0)	16 (12)	20 (15)
Full load amps (FLA)	A (@460V)	14	18	25
Motor fuse (YΔ start)	A	25 A slow (external)	35 A slow (external)	50 A slow (external)
Speed (60 Hz)	rpm	3,500	3,520	3,520
Combustion manager	Model	W-FM 54	W-FM 54	W-FM54
Air/Gas stepping motor	Model	SQM 33	SQM 33	SQM 33
Weight	lbs (kg)	approx. 412 (187)	approx. 423 (192)	approx. 445 (202)
Oil pump	model	TA3	TA4	TA5
maximum flow rate	GPH (l/h)	244 (942)	327 (1260)	438 (1690)
Oil hoses	DN/ length	3/4" / 40" (20/ 1000)	1" / 50" (25/ 1300)	1" / 50" (25/ 1300)

### Voltages and frequencies:

The burners are equipped with three phase motor in 208 - 600 V, 60 Hz as standard. Different voltage and frequency are available upon request.

### Standard burner motor:

Insulation class F, protection IP 54.

# Fuel systems

## Gas train schematic\*

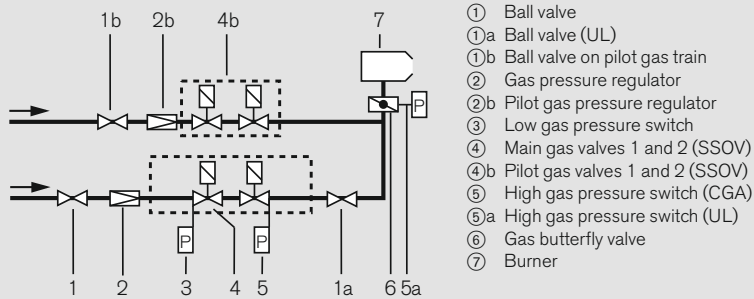

\* The above schematic shows typical gas train configuration only. The actual gas train configuration shipped with burner might differ depending on applicable codes/ regulation and application.

### Gas train arrangement

For boiler with hinged door the gas train must be installed on the opposite side of the boiler door hinge.

### Gas train installation

Gas train must be mounted tension free. Do not compensate misalignment by over tightening. Distance between burner and gas valves should be as small as possible. Pay attention to the correct gas flow direction.

### Gas train support

The gas train must be fixed and supported securely. They must not be allowed to vibrate during operation. Support suitable for the site should be fitted during installation.

### Gas meter

For commissioning a gas meter is required to verify exact gas consumption.

## Oil function schematics

### Version ZM-T

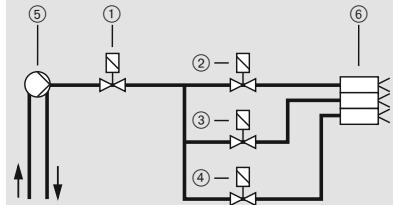

- ① Safety solenoid valve
- ② Stage 1 solenoid valve
- ③ Stage 2 solenoid valve
- ④ Stage 3 solenoid valve
- ⑤ Burner mounted oil pump
- ⑥ Nozzle assembly with 3 atomizing nozzles

### Version ZM-R

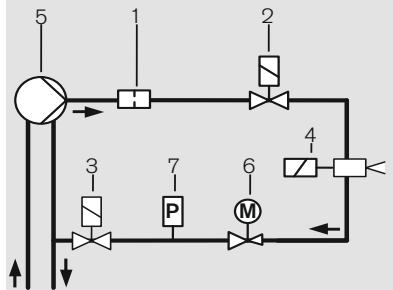

- ① Strainer
- ② Oil solenoid valve in supply line
- ③ Oil solenoid valve in return line
- ④ Nozzle head with spill type nozzle
- ⑤ Burner mounted oil pump
- ⑥ Oil regulator
- ⑦ Pressure switch in return line

# Dimensions

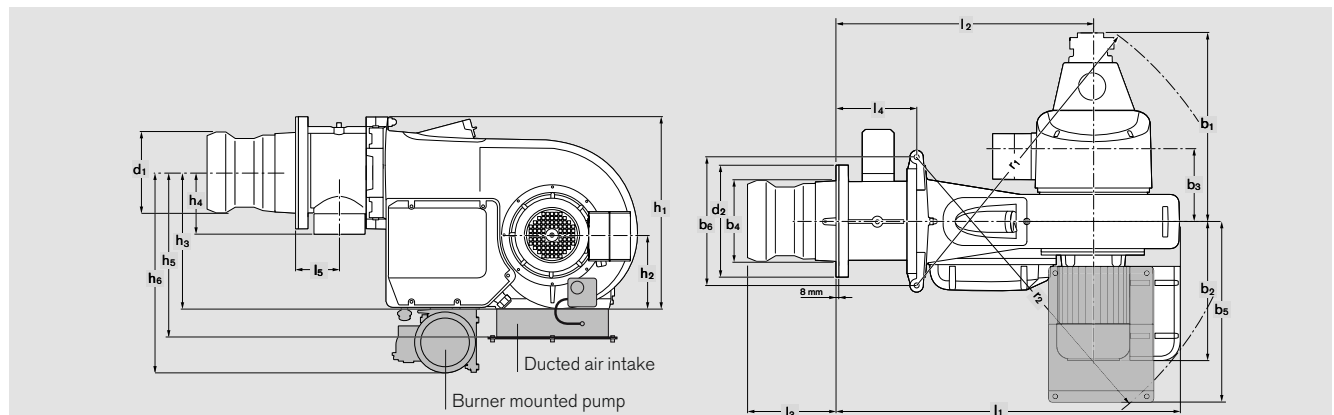

Burner-model	Dimensions in inches and (mm)												
	l <sub>1</sub>	l <sub>2</sub>	l <sub>3</sub>	l <sub>4</sub>	l <sub>5</sub>	b <sub>1</sub>	b <sub>2</sub>	b <sub>3</sub>	b <sub>4</sub>	b <sub>5</sub>	b <sub>6</sub>	r <sub>1</sub>	r <sub>2</sub> *
<b>WM-L30/1-A T</b>	37.0 (941)	24.5 (622)	11.9 - 12.8 (301 - 326)	1.7 (43)	-	18.9 (481)	20.0 (508)	10.3 (261)	11.9 (301)	22.4 (570)	17.3 (440)	39.1 (992)	43.7 (1111)
<b>WM-L30/2-A T</b>	37.0 (941)	24.5 (622)	11.9 - 12.8 (301 - 326)	1.7 (43)	-	18.9 (480)	21.6 (548)	10.3 (261)	11.9 (301)	26.4 (670)	17.3 (440)	39.1 (992)	44.8 (1137)
<b>WM-L30/1-A R</b>	37.0 (941)	24.5 (622)	11.9 - 12.8 (301 - 326)	1.7 (43)	-	19.1 (484)	20.0 (508)	10.3 (261)	11.9 (301)	22.4 (570)	17.3 (440)	39.1 (992)	43.7 (1111)
<b>WM-L30/2-A R</b>	37.0 (941)	24.5 (622)	11.9 - 12.8 (301 - 326)	1.7 (43)	-	19.2 (488)	21.6 (548)	10.3 (261)	11.9 (301)	26.4 (670)	17.3 (440)	39.1 (992)	44.8 (1137)
<b>WM-L30/3-A R</b>	37.6 (956)	25.1 (637)	11.2 - 12.8 (285 - 325)	2.3 (58)	-	19.4 (494)	21.6 (548)	10.3 (261)	11.9 (301)	26.4 (670)	17.3 (440)	39.1 (992)	44.8 (1137)
<b>WM-G30/1-A ZM</b>	45.1 (1146)	32.6 (827)	13.7 - 14.7 (349 - 374)	9.8 (248)	5.0 (128)	15.7 (398)	20.0 (508)	10.3 (261)	11.9 (301)	22.4 (570)	17.3 (440)	39.1 (992)	43.7 (1111)
<b>WM-G30/2-A ZM</b>	45.1 (1146)	32.6 (827)	13.7 - 14.7 (349 - 374)	9.8 (248)	5.0 (128)	15.7 (398)	21.6 (548)	10.3 (261)	11.9 (301)	24.0 (610)	17.3 (440)	39.1 (992)	44.8 (1137)
<b>WM-G30/3-A ZM</b>	45.9 (1166)	33.3 (847)	13.7 - 15.3 (349 - 389)	10.6 (268)	5.8 (148)	15.7 (398)	21.6 (548)	10.3 (261)	13.7 (348)	26.4 (670)	17.3 (440)	39.1 (992)	44.8 (1137)
<b>WM-GL30/1-A ZM-T</b>	45.1 (1146)	32.6 (827)	13.7 - 14.7 (349 - 374)	9.8 (248)	5.0 (128)	24.1 (612)	20.0 (508)	10.3 (261)	11.9 (301)	22.4 (570)	17.3 (440)	40.9 (1038)	43.7 (1111)
<b>WM-GL30/2-A ZM-T</b>	45.1 (1146)	32.6 (827)	13.7 - 14.7 (349 - 374)	9.8 (248)	5.0 (128)	24.0 (610)	21.6 (548)	10.3 (261)	11.9 (301)	26.4 (670)	17.3 (440)	41.3 (1048)	44.8 (1137)
<b>WM-GL30/1-A ZM-R</b>	45.1 (1146)	32.6 (827)	13.7 - 14.7 (349 - 374)	9.8 (248)	5.0 (128)	24.2 (615)	20.0 (508)	10.3 (261)	11.9 (301)	22.4 (570)	17.3 (440)	41.4 (1052)	43.7 (1111)
<b>WM-GL30/2-A ZM-R</b>	45.1 (1146)	32.6 (827)	13.7 - 14.7 (349 - 374)	9.8 (248)	5.0 (128)	24.4 (619)	21.6 (548)	10.3 (261)	11.9 (301)	26.4 (670)	17.3 (440)	41.5 (1055)	44.8 (1137)
<b>WM-GL30/3-A ZM-R</b>	45.9 (1166)	33.3 (847)	13.7 - 15.3 (349 - 389)	10.6 (268)	5.8 (148)	24.6 (625)	21.6 (548)	10.3 (261)	13.7 (348)	26.4 (670)	17.3 (440)	41.7 (1059)	44.8 (1137)
<b>WM-G30/1-A ZM-LN</b>	45.1 (1146)	32.6 (827)	15.1 - 15.9 (384 - 404)	9.8 (248)	5.0 (128)	15.7 (398)	20.0 (508)	10.3 (261)	11.9 (301)	22.4 (570)	17.3 (440)	39.1 (992)	43.7 (1111)
<b>WM-G30/2-A ZM-LN</b>	45.1 (1146)	32.6 (827)	14.7 - 16.3 (374 - 414)	9.8 (248)	5.0 (128)	15.7 (398)	21.6 (548)	10.3 (261)	11.9 (301)	24.0 (610)	17.3 (440)	39.1 (992)	44.8 (1137)
<b>WM-G30/3-A ZM-LN</b>	45.9 (1166)	33.3 (847)	15.6 - 16.5 (395 - 420)	10.6 (268)	5.8 (148)	15.7 (398)	21.6 (548)	10.3 (261)	13.7 (348)	26.4 (670)	17.3 (440)	39.1 (992)	44.8 (1137)

All dimensions are approximate. Weishaupt reserves the right to make changes in light of future developments.

# Dimensions

**Ducted air intake bottom**

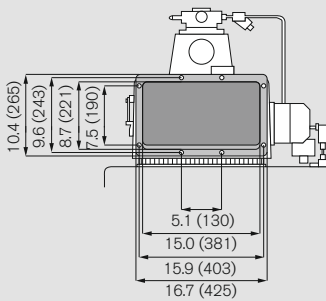

**Boiler plate mounting dimensions**

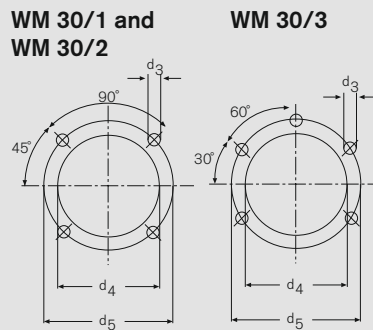

**Mounting to heat exchanger**

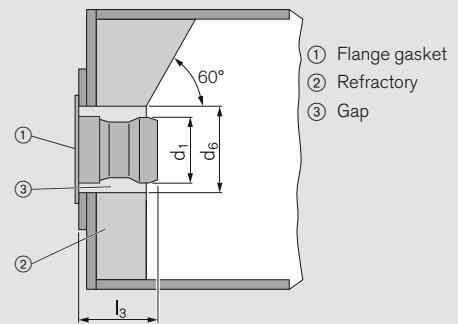

Burner-model	Dimensions in inches and (mm)											Gas butterfly size	
	$h_1$	$h_2$	$h_3$	$h_4$	$h_5$	$h_6$	$d_1$	$d_2$	$d_3$	$d_4$	$d_5$		$d_6$
WM-L30/1-A T	27.4 (695)	10.1 (256)	19.9 (505)	-	24.4 (621)	26.8 (680)	11.4 (290)	15.0 (380)	M12	12.0 (305)	13.0 (330)	14.2 (360)	-
WM-L30/2-A T	27.4 (695)	10.1 (256)	19.9 (505)	-	24.4 (621)	26.8 (680)	11.8 (300)	15.0 (380)	M12	12.0 (305)	13.0 (330)	14.2 (360)	-
WM-L30/1-A R	27.4 (695)	10.1 (256)	19.9 (505)	-	24.4 (621)	28.0 (710)	11.4 (290)	15.0 (380)	M12	12.0 (305)	13.0 (330)	14.2 (360)	-
WM-L30/2-A R	27.4 (695)	10.1 (256)	19.9 (505)	-	24.4 (621)	28.3 (720)	11.8 (300)	15.0 (380)	M12	12.0 (305)	13.0 (330)	14.2 (360)	-
WM-L30/3-A R	28.7 (730)	10.1 (256)	19.9 (505)	-	24.4 (621)	28.3 (720)	14.4 (367)	17.7 (450)	M12	14.8 (375)	15.7 (400)	16.5 (420)	-
WM-G30/1-A ZM	27.4 (695)	10.1 (256)	19.9 (505)	8.3 (212)	24.4 (621)	-	11.4 (290)	15.0 (380)	M12	12.0 (305)	13.0 (330)	14.2 (360)	DN 80
WM-G30/2-A ZM	27.4 (695)	10.1 (256)	19.9 (505)	8.3 (212)	24.4 (621)	-	11.8 (300)	15.0 (380)	M12	12.0 (305)	13.0 (330)	14.2 (360)	DN 80
WM-G30/3-A ZM	28.7 (730)	10.1 (256)	19.9 (505)	9.1 (232)	24.4 (621)	-	14.4 (367)	17.7 (450)	M12	14.8 (375)	15.7 (400)	16.5 (420)	DN 80
WM-GL30/1-A ZM-T	27.4 (695)	10.1 (256)	19.9 (505)	8.3 (212)	24.4 (621)	26.8 (680)	11.4 (290)	15.0 (380)	M12	12.0 (305)	13.0 (330)	14.2 (360)	DN 80
WM-GL30/2-A ZM-T	27.4 (695)	10.1 (256)	19.9 (505)	8.3 (212)	24.4 (621)	26.8 (680)	11.8 (300)	15.0 (380)	M12	12.0 (305)	13.0 (330)	14.2 (360)	DN 80
WM-GL30/1-A ZM-R	27.4 (695)	10.1 (256)	19.9 (505)	8.3 (212)	24.4 (621)	28.0 (710)	11.4 (290)	15.0 (380)	M12	12.0 (305)	13.0 (330)	14.2 (360)	DN 80
WM-GL30/2-A ZM-R	27.4 (695)	10.1 (256)	19.9 (505)	8.3 (212)	24.4 (621)	28.3 (720)	11.8 (300)	15.0 (380)	M12	12.0 (305)	13.0 (330)	14.2 (360)	DN 80
WM-GL30/3-A ZM-R	28.7 (730)	10.1 (256)	19.9 (505)	9.1 (232)	24.4 (621)	28.3 (720)	14.4 (367)	17.7 (450)	M12	14.8 (375)	15.7 (400)	16.5 (420)	DN 80
WM-G30/1-A LN	27.4 (695)	10.1 (256)	19.9 (505)	8.3 (212)	24.4 (621)	-	11.0 (280)	15.0 (380)	M12	12.0 (305)	13.0 (330)	14.2 (360)	DN 80
WM-G30/2-A LN	27.4 (695)	10.1 (256)	19.9 (505)	8.3 (212)	24.4 (621)	-	11.7 (296)	15.0 (380)	M12	12.0 (305)	13.0 (330)	14.2 (360)	DN 80
WM-G30/3-A LN	28.7 (730)	10.1 (256)	19.9 (505)	9.1 (232)	24.4 (621)	-	14.0 (356)	17.7 (450)	M12	14.8 (375)	15.7 (400)	16.5 (420)	DN 80

All dimensions are approximate. Weishaupt reserves the right to make changes in light of future developments.

## Fuel savings, emissions reductions: Patented multiflam® technology



**Weishaupt's patented multiflam® technology allows compliance with very stringent emission limits without the need for expensive additional equipment. The emissions reduction is accomplished by using innovative mixing assembly and applying fuel distribution principles.**

Weishaupt multiflam® burners have been proven in the field for more than 10 years. They are especially suited for applications with stringent emission limits.

The latest monarch® burners have adopted this technology and brought a combination of flexibility and low emissions into medium capacity range.

### **Exemplary emission values**

multiflam® 3LN version burners further reduce NO<sub>x</sub> emissions below the level which can be achieved by standard mixing head. These additional reductions are accomplished by using special mixing assembly applying fuel distribution principles.

Combustion values also depend on combustion chamber geometry, volumetric loading and boiler design. Certain conditions such as combustion chamber dimensions, measurement tolerances, temperature, humidity, etc. must be verified in order to guarantee emission levels.

# Burner selection Oil burners

## WM30 multiflam<sup>®</sup> burners vers. 3LN

**Burner model**  
Combustion head  
Capacity MBTU/h

**WM-L30/1-A R-3LN**  
WM-L30/1-3LN, Ø 215 / Ø 22  
#2 Oil 1,540 – 11,945

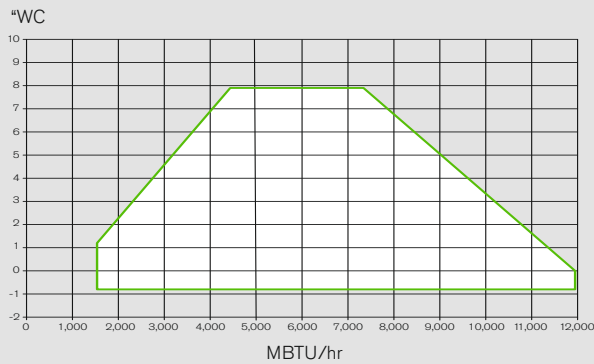

**Burner model**  
Combustion head  
Capacity MBTU/h

**WM-L30/2-A R-3LN**  
WM30/2+3-3LN, Ø 220 / Ø 25  
#2 Oil 2,050 – 15,360

**Burner model**  
Combustion head  
Capacity MBTU/h

**WM-L30/3-A R-3LN**  
WM30/2+3-3LN, Ø 220 / Ø 25  
#2 Oil 2,050 – 17,065

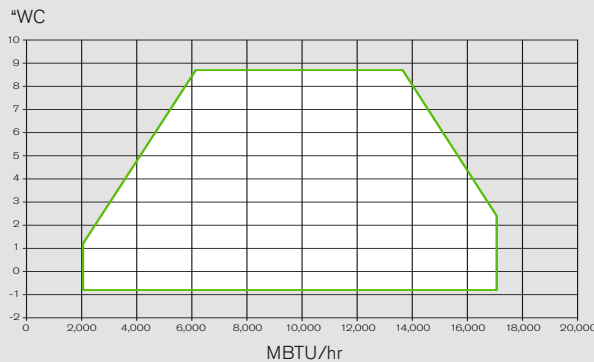
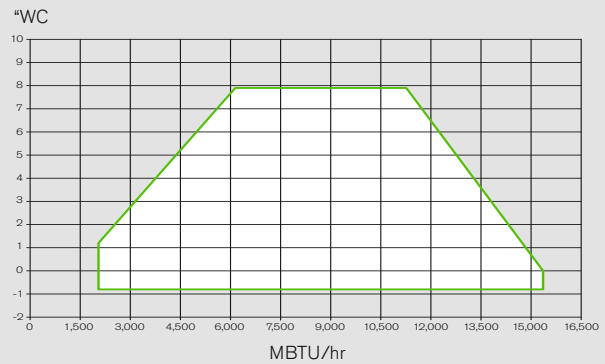

**The firing rates are based on an installation altitude of 1,640 ft (500 m). Burner capacity is based on #2 oil with calorific value of 140,000 BTU/Gallon**

Voltagés and frequencies:  
The burners are equipped with three phase motor in 208 - 600 V, 60 Hz as standard. Different voltage and frequency are available upon request.

Standard burner motor:  
Insulation class F, protection IP 54.

\* 57Hz operation with VFD

### Burner order numbers

Burner model	Version	Order No.
WM-L30/1-A	R	215 320 11
WM-L30/2-A	R	215 320 21
WM-L30/3-A	R	215 320 31

# Burner selection gas and dual fuel burners WM30 multiflam<sup>®</sup> burners vers. 3LN

**Burner model** WM-G30/1-A/ ZM 3LN  
WM-GL30/1-A/ ZM-R 3LN  
Combustion head WM30/1-3LN, Ø 215 / Ø 22  
Capacity MBTU/h Natural gas 1,365 – 11,945  
Propane 1,365 – 11,945  
#2 Oil 1,535 – 11,945

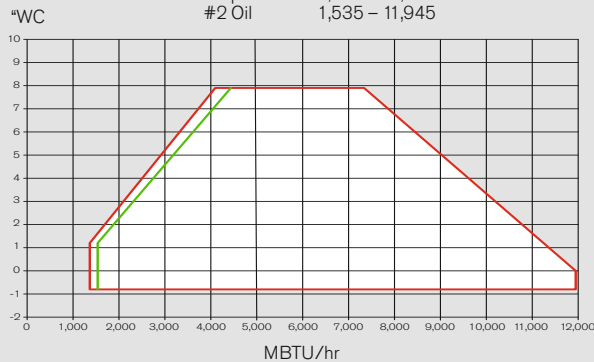

**Burner model** WM-G30/2-A/ ZM 3LN  
WM-GL30/2-A/ ZM-R 3LN  
Combustion head WM30/2+3-3LN, Ø 220 / Ø 25  
Capacity MBTU/h Natural gas 1,710 – 15,355  
Propane 1,710 – 15,355  
#2 Oil 2,050 – 15,355

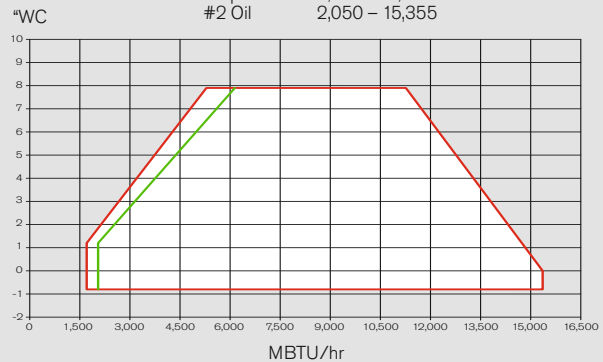

**Burner model** WM-G30/3-A/ ZM 3LN \*  
WM-GL30/3-A/ ZM-R 3LN \*  
Combustion head WM30/2+3-3LN, Ø 220 / Ø 25  
Capacity MBTU/h Natural gas 1,710 – 17,065  
Propane 1,710 – 17,065  
#2 Oil 2,050 – 17,065

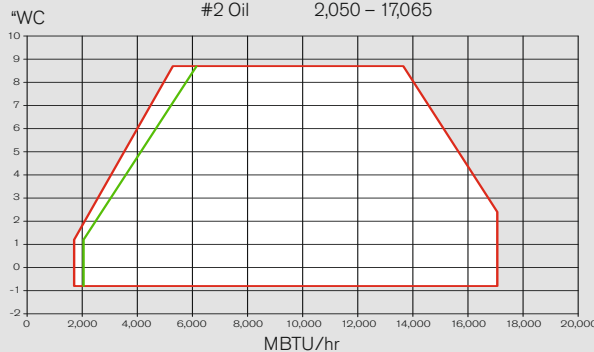

\* 57Hz operation with VFD

Natural gas/ propane ————  
#2 Oil ————

### Burner order numbers

Burner model	Version	Order No.
WM-G30/1-A	ZM-3LN	217 317 12
WM-G30/2-A	ZM-3LN	217 318 12
WM-G30/3-A	ZM-3LN	217 319 12

The firing rates are based on an installation altitude of 0 ft (0 m). A reduction of burner capacity of 1 % for every 325 ft (100 m) should be taken into consideration in case of installation altitude above 0 ft.

Voltages and frequencies:

The burners are equipped with three phase motor in 208 - 600 V, 60 Hz as standard. Different voltage and frequency are available upon request.

Standard burner motor:

Insulation class F, protection IP 54.

Burner model	Version	Order No.
WM-GL30/1-A	ZM-R-3LN	218 325 12
WM-GL30/2-A	ZM-R-3LN	218 326 12
WM-GL30/3-A	ZM-R-3LN	218 327 12

# Standard scope of supply

Description		WM-L30-R 3LN	WM-G30 ZM 3LN	WM-GL30 ZM-R 3LN
Burner housing, Hinge flange, housing cover, Weishaupt burner motor, air intake housing, fan wheel, combustion head, ignition unit, ignition cable, ignition electrodes, combustion manager with operating unit, flame sensor, stepping motors, flange gasket, limit switch on hinge flange, fixing screws		●	●	●
Digital combustion manager W-FM 100 W-FM 200	WM30/1, WM30/2 WM30/3	● ●	● ●	● ●
Two gas safety shut off valves		-	●	●
Gas butterfly valve		-	●	●
Air pressure switch		-	●	●
Adjustable mixing head		●	●	●
Stepping motor for fuel/air compound regulation with W-FM: Stepping motor for air damper Stepping motor for gas butterfly valve Stepping motor for oil regulator Stepping motor for mixing head		● - ● ● ●	● ● - ●	● ● ● ● ●
Oil pressure switch in return line		●	-	●
Oil pressure switch in supply line DSA58	WM30/1, WM30/2 WM30/3	○ ●	- -	○ ●
Burner mounted oil pump <sup>1)</sup>		●	-	●
Oil hoses		●	-	●
2 oil solenoid valves in each supply and return line, oil regulator, nozzle head, spill type nozzles		●	-	●
Magnetic clutch <sup>1)</sup>	WM30/1, WM30/2 WM30/3	○ -	- -	● -
Motor speed control	WM30/1, WM30/2 WM30/3	○ ●	○ ●	○ ●
IP 54 protection		●	●	●

● Standard  
○ Optional

<sup>1)</sup> WM30/3 3LN comes as standard with frequency drive (W-FM 200)  
WM30/3 3LN comes with oil pump unit SMG1629



## Special equipment oil, gas and dual fuel burners WM-30 multiflam<sup>®</sup> burners vers. 3LN

Oil burners WM-L30/... -A R-3LN		WM-L30/1	WM-L30/2	WM-L30/3
Combustion head extension	by 6" (150 mm)	on request	on request	on request
	by 12" (300 mm)	on request	on request	on request
Connection for air intake duct		on request	on request	on request
Solenoid valve for air pressure switch test, continuous run fan or post purge		250 030 21	250 030 21	250 030 21
W-FM 200 in lieu of W-FM 100 with built-in modulating controller, speed control module with optional fuel metering	fitted	210 031 61	210 031 61	standard
	loose	on request	on request	on request
Speed control with burner motor mounted VFD (W-FM 200 required)		210 031 48	210 031 49	standard
Speed control with separate VFD (W-FM 200 required)		210 030 98	210 030 98	on request
Special voltages		on request	on request	on request
Gas and dual fuel burners WM-G(GL)30/... -A (ZM)R-3LN		WM-GL 30/1-A	WM-GL 30/2-A	WM-GL 30/3-A
Combustion head extension	by 6" (150 mm)	on request	on request	on request
	by 12" (300 mm)	on request	on request	on request
Solenoid valve for air press. switch test - cont. run fan or post purge		on request	on request	on request
Flange adapter for ducted air intake		on request	on request	on request
W-FM 100 loose instead of burner mounted		on request	on request	on request
W-FM 200 instead of W-FM 100 with built in modulating controller and VFD control with optional fuel metering	fitted	210 031 61	210 031 61	standard
	loose	on request	on request	on request
Speed control with burner mounted VFD (W-FM 54/200 required)	G	210 030 97	210 031 49	standard
	GL	on request	on request	on request
Speed control with separate VFD (W-FM 54/200 required)		on request	on request	on request
Special voltages		on request	on request	on request

# Technical data

## WM 30 multiflam<sup>®</sup> burner vers. 3LN

Oil burners WM-L30/.. -A R 3LN		L30/1	L30/2	L30/3
Burner motor	Weishaupt model	WM-D 132/170-2/10K0	WM-D 132/210-2/14K0	WM-D 132/210-2/17K0
Rated power	HP (kW)	16 (12)	20 (15)	22.8 (17)
Full load amps (FLA)	A (@460 V)	18	25	34
Motor fuse (YΔ start)	A	35 A slow (external)	50 A slow (external)	60 A slow (external)
Speed (60 Hz)	rpm	3,520	3,520	3,320 <sup>1)</sup>
Combustion manager	Model	W-FM 100	W-FM 100	W-FM 200
Flame sensor	Type	QRA73	QRA73	QRA73
Stepping motor Air/Oil	Model	SQM 45	SQM 45	SQM 45
Weight	lbs (kg)	approx. 445 (202)	approx. 445 (202)	approx. 530 (240)
Oil pump	model	TA4	TA5	Pump unit with motor SMG1629
maximum flow rate	GPH (l/h)	327 (1260)	438 (1690)	389 (1500)
Oil hoses	DN/ length	1" / 50" (25/ 1300)	1" / 50" (25/ 1300)	1" / 50" (25/ 1300)

<sup>1)</sup> max speed 57 Hz with frequency drive

### Voltages and frequencies:

The burners are equipped with three phase motor in 208 - 600 V, 60 Hz as standard.  
Different voltage and frequency are available upon request.

### Standard burner motor:

Insulation class F, protection IP 54.

# Technical data

## Gas and dual fuel burners

Gas burners WM-G30/.. -A ZM 3LN		G30/1	G30/2	G30/3
Burner motor	Weishaupt model	WM-D 132/170-2/10K0	WM-D 132/210-2/14K0	WM-D 132/210-2/17K0
Rated power	HP (kW)	16 (12)	20 (15)	22.8 (17)
Full load amps (FLA)	A (@460 V)	18	25	34
Motor fuse (YΔ start)	A	35 A slow (external)	50 A slow (external)	60 A slow (external)
Speed (60 Hz)	rpm	3,520	3,520	3,320 <sup>1)</sup>
Combustion manager	Model	W-FM 100	W-FM 100	W-FM 200
Flame sensor	Type	Flame rod	Flame rod	Flame rod
Air/Gas stepping motor	Model	SQM45	SQM45	SQM45
Mixing head stepping motor	Model	SQM45	SQM48	SQM48
Weight	lbs (kg)	approx. 406 (184)	approx. 406 (184)	approx. 439 (199)

Dual fuel burners WM-GL30/.. A ZM R 3LN		WM-GL 30/1-A	WM-GL 30/2-A	WM-GL 30/3-A
Burner motor	Weishaupt model	WM-D 132/170-2/10K0	WM-D 132/210-2/14K0	WM-D 132/210-2/17K0
Rated power	HP (kW)	16 (12)	20 (15)	22.8 (17)
Full load amps (FLA)	A (@460V)	18	25	34
Motor fuse (YΔ start)	A	35 A slow (external)	50 A slow (external)	60 A slow (external)
Speed (60 Hz)	rpm	3,520	3,520	3,320 <sup>1)</sup>
Combustion manager	Model	W-FM 100	W-FM 100	W-FM 200
Flame sensor	Type	QRA73	QRA73	QRA73
Air/Gas stepping motor	Model	SQM45	SQM45	SQM45
Mixing head stepping motor	Model	SQM45	SQM48	SQM48
Weight	lbs (kg)	approx. 478 (217)	approx. 478 (217)	approx. 540 (245)
Oil pump	model	TA4	TA5	Pump unit with motor SMG1629
maximum flow rate	GPH (l/h)	327 (1260)	438 (1690)	389 (1500)
Oil hoses	DN/ length	1" / 50" (25/ 1300)	1" / 50" (25/ 1300)	1" / 50" (25/ 1300)

### Voltages and frequencies:

The burners are equipped with three phase motor in 208 - 600 V, 60 Hz as standard. Different voltage and frequency are available upon request.

### Standard burner motor:

Insulation class F, protection IP 54.

# Dimensions

multiflam® version 3LN

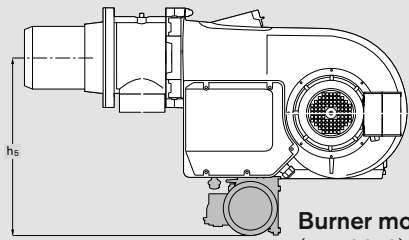
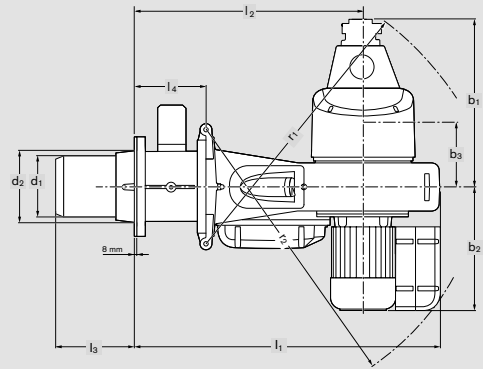
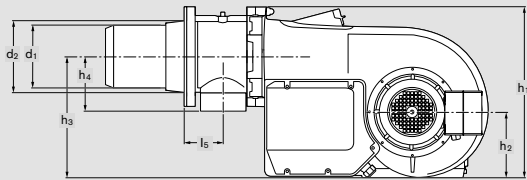

**Burner mounted oil pump unit**  
(WM 30/3)

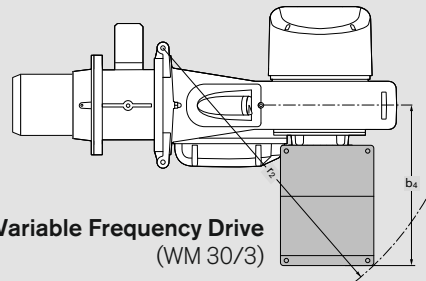

**Variable Frequency Drive**  
(WM 30/3)

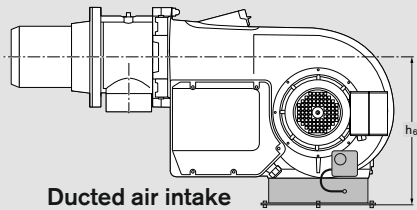

**Ducted air intake**

optional

## Boiler plate mounting dimensions

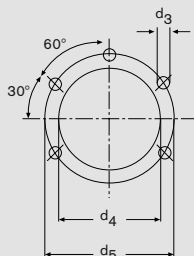

## Mounting to heat exchanger

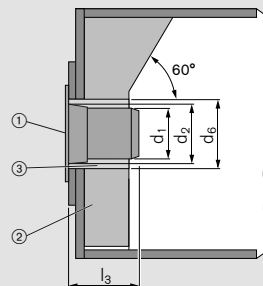

- ① Flange gasket
- ② Refractory
- ③ Gap

Burner flame tube needs to protrude by approx 2" over the refractory (②). Refractory may take conical shape (min 60°).

Burner-model	Dimensions in inches (mm)															
	l <sub>1</sub>	l <sub>2</sub>	l <sub>3</sub>	l <sub>4</sub>	l <sub>5</sub>	b <sub>1</sub>	b <sub>2</sub>	b <sub>3</sub>	b <sub>4</sub>	h <sub>1</sub>	h <sub>2</sub>	h <sub>3</sub>	h <sub>4</sub>	h <sub>5</sub>	h <sub>6</sub>	
WM-L30/1-A R-3LN	45.9 (1166)	33.3 (847)	18.6 (473)	10.6 (268)	5.8 (148)	19.2 (488)	21.6 (548)	10.3 (261)	24.8 (630)	28.7 (730)	10.1 (256)	19.9 (505)	–	28.3 (720)	24.4 (621)	
WM-L30/2-A R-3LN	45.9 (1166)	33.3 (847)	18.9 (480)	10.6 (268)	5.8 (148)	19.4 (494)	21.6 (548)	10.3 (261)	26.4 (670)	28.7 (730)	10.1 (256)	19.9 (505)	–	28.3 (720)	24.4 (621)	
WM-L30/3-A R-3LN	45.9 (1166)	33.3 (847)	18.9 (480)	10.6 (268)	5.8 (148)	17.6 (446)	21.6 (548)	10.3 (261)	26.4 (670)	28.7 (730)	10.1 (256)	19.9 (505)	–	28.3 (720)	24.4 (621)	
WM-G30/1-A ZM-3LN	45.9 (1166)	33.3 (847)	18.6 (473)	10.6 (268)	5.8 (148)	15.7 (398)	21.6 (548)	10.3 (261)	24.8 (630)	28.7 (730)	10.1 (256)	19.9 (505)	9.1 (232)	–	24.4 (621)	
WM-G30/2-A ZM-3LN	45.9 (1166)	33.3 (847)	18.9 (480)	10.6 (268)	5.8 (148)	15.7 (398)	21.6 (548)	10.3 (261)	26.4 (670)	28.7 (730)	10.1 (256)	19.9 (505)	9.1 (232)	–	24.4 (621)	
WM-G30/3-A ZM-3LN	45.9 (1166)	33.3 (847)	18.9 (480)	10.6 (268)	5.8 (148)	15.7 (398)	21.6 (548)	10.3 (261)	26.4 (670)	28.7 (730)	10.1 (256)	19.9 (505)	9.1 (232)	–	24.4 (621)	
WM-GL30/1-A ZM-R-3LN	45.9 (1166)	33.3 (847)	18.6 (473)	10.6 (268)	5.8 (148)	24.4 (619)	21.6 (548)	10.3 (261)	24.8 (630)	28.7 (730)	10.1 (256)	19.9 (505)	9.1 (232)	28.3 (720)	24.4 (621)	
WM-GL30/2-A ZM-R-3LN	45.9 (1166)	33.3 (847)	18.9 (480)	10.6 (268)	5.8 (148)	24.6 (625)	21.6 (548)	10.3 (261)	26.4 (670)	28.7 (730)	10.1 (256)	19.9 (505)	9.1 (232)	28.3 (720)	24.4 (621)	
WM-GL30/3-A ZM-R-3LN	45.9 (1166)	33.3 (847)	18.9 (480)	10.6 (268)	5.8 (148)	17.6 (446)	21.6 (548)	10.3 (261)	26.4 (670)	28.7 (730)	10.1 (256)	19.9 (505)	9.1 (232)	28.3 (720)	24.4 (621)	

  

Burner-model	Dimensions in inches (mm)						Size gas butterfly	d <sub>3</sub>	d <sub>4</sub>	d <sub>5</sub>	d <sub>6</sub>
	r <sub>1</sub>	r <sub>2</sub>	d <sub>1</sub>	d <sub>2</sub>							
WM-L30/1-A R-3LN	39.1 (992)	44.8 (1137)	11.7 (296)	13.7 (348)	–	–	M12	14.8 (375)	15.7 (400)	15.0 (380)	
WM-L30/2-A R-3LN	39.1 (992)	44.8 (1137)	12.7 (322)	13.7 (348)	–	–	M12	14.8 (375)	15.7 (400)	15.0 (380)	
WM-L30/3-A R-3LN	39.1 (992)	45.3 (1151)	12.7 (322)	13.7 (348)	–	–	M12	14.8 (375)	15.7 (400)	15.0 (380)	
WM-G30/1-A ZM-3LN	39.1 (992)	44.8 (1137)	11.7 (296)	13.7 (348)	DN80	–	M12	14.8 (375)	15.7 (400)	15.0 (380)	
WM-G30/2-A ZM-3LN	39.1 (992)	44.8 (1137)	12.7 (322)	13.7 (348)	DN80	–	M12	14.8 (375)	15.7 (400)	15.0 (380)	
WM-G30/3-A ZM-3LN	39.1 (992)	45.3 (1151)	12.7 (322)	13.7 (348)	DN80	–	M12	14.8 (375)	15.7 (400)	15.0 (380)	
WM-GL30/1-A ZM-R-3LN	41.5 (1055)	44.8 (1137)	11.7 (296)	13.7 (348)	DN80	–	M12	14.8 (375)	15.7 (400)	15.0 (380)	
WM-GL30/2-A ZM-R-3LN	41.7 (1059)	44.8 (1137)	12.7 (322)	13.7 (348)	DN80	–	M12	14.8 (375)	15.7 (400)	15.0 (380)	
WM-GL30/3-A ZM-R-3LN	39.1 (992)	45.3 (1151)	12.7 (322)	13.7 (348)	DN80	–	M12	14.8 (375)	15.7 (400)	15.0 (380)	

All dimensions are approximate. Weishaupt reserves the right to make changes in light of future developments.

# Fuel systems

## Gas train schematic\*

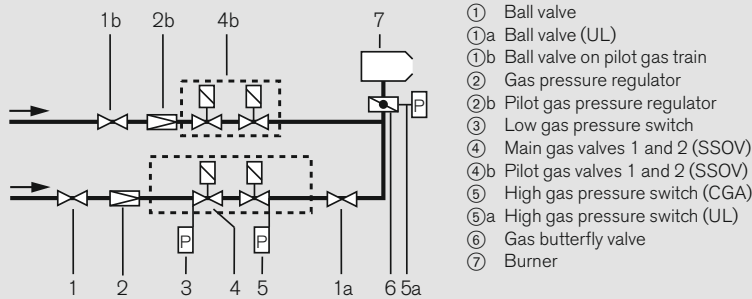

\* The above schematic shows typical gas train configuration only. The actual gas train configuration shipped with burner might differ depending on applicable codes/ regulation and application.

### Gas train arrangement

For boiler with hinged door the gas train must be installed on the opposite side of the boiler door hinge.

### Gas train installation

Gas train must be mounted tension free. Do not compensate misalignment by over tightening. Distance between burner and gas valves should be as small as possible. Pay attention to the correct gas flow direction.

### Gas train support

The gas train must be fixed and supported securely. They must not be allowed to vibrate during operation. Support suitable for the site should be fitted during installation.

### Gas meter

For commissioning a gas meter is required to verify exact gas consumption.

## Oil function schematics

### WM30/1 and WM30/2

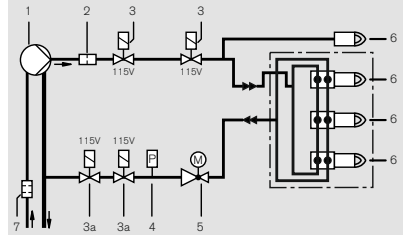

### WM30/3

#### with SMG1629 motor pump unit

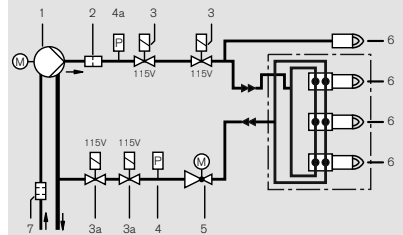

- 1 Oil pump
- 2 Strainer
- 3 Oil solenoid valves in supply line (connected in series with 3a)
- 3a Oil solenoid valves in return line (connected in series with 3) - mounted against flow direction
- 4 Oil pressure switch in return line
- 4a Oil pressure switch in supply line
- 5 Oil regulator
- 6 Nozzle head with shut off device
- 7 External oil filter<sup>Ⓞ</sup>

Ⓞ not standard burner's scope of supply

That is not a Facade. Weishaupt has been one of the leading company in heating and combustion industry since years with headquarter in Schwendi and branches all over the world. That is Reliability.



**Weishaupt is Reliability.**

*The family business in Schwendi was established by Max Weishaupt in 1932. Represented in 55 countries by branch offices and subsidiaries Weishaupt is international leader in the areas of combustion technology and heating applications.*

*Trustworthy, quality, good customer service, innovation and experience are values on which the Pioneer Max Weishaupt established his company. All this combined in a word is reliability.*

*Therefore stands Weishaupt today.*



# – weishaupt –

Weishaupt Corporation  
6280 Danville Road  
Mississauga, ON L5T 2H7, Canada  
Ph: (905) 564 0946  
Fax: (905) 564 0949  
www.weishaupt-corp.com

Weishaupt America Inc.  
2587 Millenium Drive, Unit A  
Elgin, IL 60124, USA  
Ph: (847) 531 5800  
Fax: (847) 531 5855  
www.weishaupt-america.com

Print No. 83211616, February 2015  
Printed in Germany. All rights reserved.



Regular maintenance reduces heating costs and environmental pollution. Only a properly adjusted burner can save energy and be environmentally friendly. Behind each Weishaupt burner stands the whole Weishaupt customer service organization. The outstanding efforts made in maintenance and service justify the enormous trust placed in Weishaupt's burners, for at Weishaupt, product and customer service belong together.

Weishaupt customer service is there for you all year round. Whenever you need help, be it the supply of spare parts, technical advice or a site visit. We are there when you need us.