

Short-circuit and earth fault indicators
Remote monitoring
Voltage detectors and detecting systems
Earthing devices

You will find what
you are looking for

Dipl.-Ing. H. Horstmann GmbH
Humboldtstraße 2
42579 Heiligenhaus

T +49 2056 976-0
F +49 2056 976-140

info@horstmannmbh.com
www.horstmannmbh.com









Short-circuit and earth fault indicators		
	General information	10
	You will find what you are looking for	12
	Product matrix – Short-circuit indicators Earth fault indicators	14 15
	Product matrix – Short-circuit and earth fault indicators	16
	Product matrix – Directional fault indicators	18
	Product matrix – Directional fault indicators with monitoring	19
Mechanical indicators		
	Rotor indicator	20
	Fluid indicator	21
Short-circuit indicators		
	Opto F 3.0	22
	Sigma 2.0	24
	Alpha M Alpha E	26
Earth fault indicators		
	Earth 4.0	27
	Earth Zero Earth Zero Flag	28
Short-circuit and earth fault indicators		
	Opto F+E 3.0	30
	Sigma <i>plus</i>	32
	Sigma F+E 2.0 Sigma F+E 3 2.0	34
	ComPass A	36
	ComPass A 2.0	38

The contents, performance characteristics and diagrams listed in this catalogue are not always applicable in the form described in the specific application or may change due to further developments of the products. The textual content and illustrations have been processed with the greatest care. Nevertheless, errors cannot be completely excluded. The desired performance characteristics are only binding if they are expressly agreed upon when the contract is concluded. Delivery possibilities and technical changes reserved.







The names, trade names and descriptions of goods etc. given in this catalogue are subject to the guidelines of the respective manufacturer. Dipl.-Ing. H. Horstmann GmbH does not assume any obligation to keep this catalogue up to date.





Directional fault indicators		
	Equipment set options	40
	Project planning	41
	Sigma D Sigma D+ Sigma D++	42
	ComPass B	44
	ComPass B 2.0 ComPass Bs 2.0	46
Accessories		
	Phase current transformers	48
	Single-phase current sensors	50
	Summation current transformers	51
	Summation current sensors	51
	Product matrix – Capacitive and resistive voltage signal	52
	Voltage sensors	54
	Accessories	56
Special indicators		
	ComPass BN	58
	Trip Flag	60



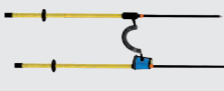
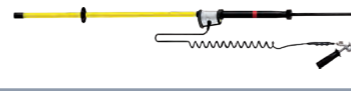







Overhead faulted circuit indicators		
	Product matrix – Overhead faulted circuit indicators	62
	Navigator LM Navigator LM HV	64
	Navigator LED + Flag	66
	Navigator LM Radio	68
	Smart Navigator Smart Navigator HV	70
	Smart Navigator DFCI HV	72
	Smart Navigator 2.0	74
	Accessories	76

Remote monitoring		
	General information	77
	Product matrix – Remote monitoring	78
	iHost	81
	Reporter 3.0	86
	Reporter 4.0	88
	ComPass AX12	90
	ComPass BX12	92
	Radio Reporter 2.0	94
	Smart Reporter	96

⚡ Voltage detectors and voltage detecting systems		
	General information	99
Integrated voltage detecting systems		
	Product matrix – Integrated voltage detecting systems (VDS)	100
	Wega 1.2 C	102
	Wega 1.2 C vario	104
	Wega 2.2 C	106
	Wega 3	108
	Wega LRM	109
	Wega T1	112
	Wega T1 vario	113
Voltage detecting and voltage indication systems		
	Orion 3.1 Orion M1	114
	HR-ST LRM-ST	116
	Interface adapter converter	117
	HR interface cable	110
	PSA interface cable	111

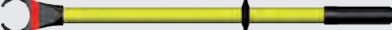
Voltage detectors		
	Product matrix – Voltage detectors	118
	FL-I	120
	TP-I	121
	Comet BL-I Comet BL-A	122
	Comet BK-I Comet BK-A	124
	Comet BS-I Comet BS-A	126
	BO-A 2.0	128
Phase comparator		
	Compare 2.0	130
	PG II	132
Voltmeter		
	BL-M	134
Accessories		
	Accessories	137
	Maintenance test	136

⚡ Earthing devices and accessories		
	General information	138
Earthing and short-circuiting devices		
	Three-phase device with ball tongs	140
	Three-phase device with universal line clamp	141
	Single-phase device without connection elements	142
	Short-circuiting bars	143

Connection points and clamps		
	Line connection points	144
	Line clamps	145
	Earth connection points	146
	Earth clamps Earth connecting elements	148
Devices for installations		
	Earthing sticks	150
	Hot sticks	151
	Operating rods	152
	Fuse tongs	153
Accessories		
	Fuse testing devices	154
	Wall holders	155
	Accessories	156
	Insulating protective barrier	157

Technical appendix		
	Dimension drawings	158
	Weights	162
	Order inquiry	168

Company profile



Head office in Heiligenhaus

Dipl.-Ing. H. Horstmann GmbH is a medium-sized company based in Heiligenhaus near Düsseldorf (Germany). The company was founded in 1946 by Heinrich Horstmann. Since that time it has been a successful family-owned company. Due to its long experience and the ongoing expansion activities in research and development as well as in production facilities Dipl.-Ing. H. Horstmann GmbH is today recognized as the leading manufacturer in medium voltage technology for:

- short-circuit and earth fault indicators
- solutions for remote monitoring
- voltage detectors and voltage detecting systems
- earthing devices and accessories

The worldwide distribution is covered by both our own highly qualified sales force and trade agents.

Our products meet the highest quality requirements and are developed and manufactured in own production facilities in Germany. In order to respond to these demands, we have a very high vertical depth of production (e. g. own SMD assembly lines) as well as an own research and development department with state-of-the-art testing and measuring equipment. Besides the electronics manufacturing, we have also a mechanical production facility for safety material.

Since 1996 our company has been certified according to DIN EN ISO 9001.



In-house manufacturing



Component testing



High voltage laboratory

Short-circuit and earth fault indicators

General information



Horstmann offers a comprehensive range of short-circuit and earth fault indicators, which are characterised by extremely high reliability, top quality and state-of-the-art functions.

There are different products and system solutions for medium voltage underground cable and overhead line networks with and without directional fault indication. They are suitable for radially fed, open ring and closed ring networks as well as for networks with a distributed energy generation. The following applies for all applications:

If a fault occurs:

- Quick identification of the fault location, immediate local display and communication to SCADA
- Targeted de-energising/switching
- Quick restoration of power supply

This means: utilities can minimise the time and effort in searching for faults and benefit from high availability of energy supply. This helps them save costs and optimise their earnings.

With continuous monitoring:

- High transparency: Provision of high accuracy current and other measurements from the distribution network
- Transmission of simple station reports like door contact, temperature alarm and status of the intelligent substation
- Simple upgrading of existing medium-voltage switchgears with retrofit solutions

With this, utilities will always have an overview of the situation in the network as well as being able to create predictive maintenance programs.

The product series for cable networks:

The **Sigma** series provides short-circuit and earth fault indicators for networks with a low-impedance neutral earthing.

The **Sigma D** series provides directional short-circuit and earth fault indicators for networks with a low-impedance neutral earthing as well as compensated and isolated networks (Sigma D+ and Sigma D++) and networks with distributed energy generation.

The **ComPass B** series is for situations requiring highly accurate network monitoring in combination with directional fault indication. ComPass Bs 2.0 is used for situations where remote switching is required.

The diagram on the right side shows two types of faults:

Left: A fault that leads to line de-energisation when the circuit-breaker in the substation is opened. The short-circuit and earth fault indicators have tripped between substation and towards the fault location.

Right: A fault which does not lead to network de-energisation. The circuit-breaker remains closed. The short-circuit and earth fault indicators point from two directions to the fault location.

The products marked with an ePLAN logo are available in the ePLAN-data Portal with the circuit diagram and terminal assignment.

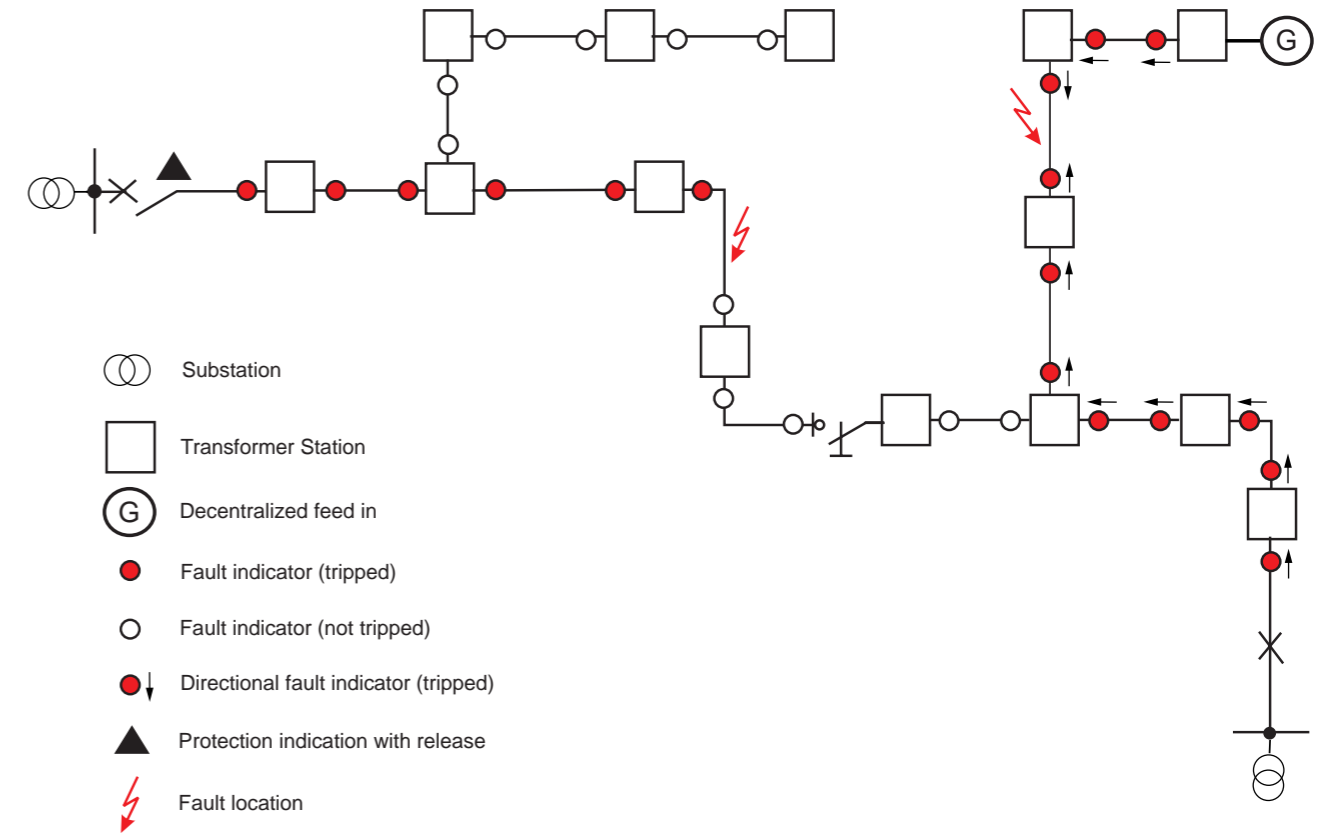

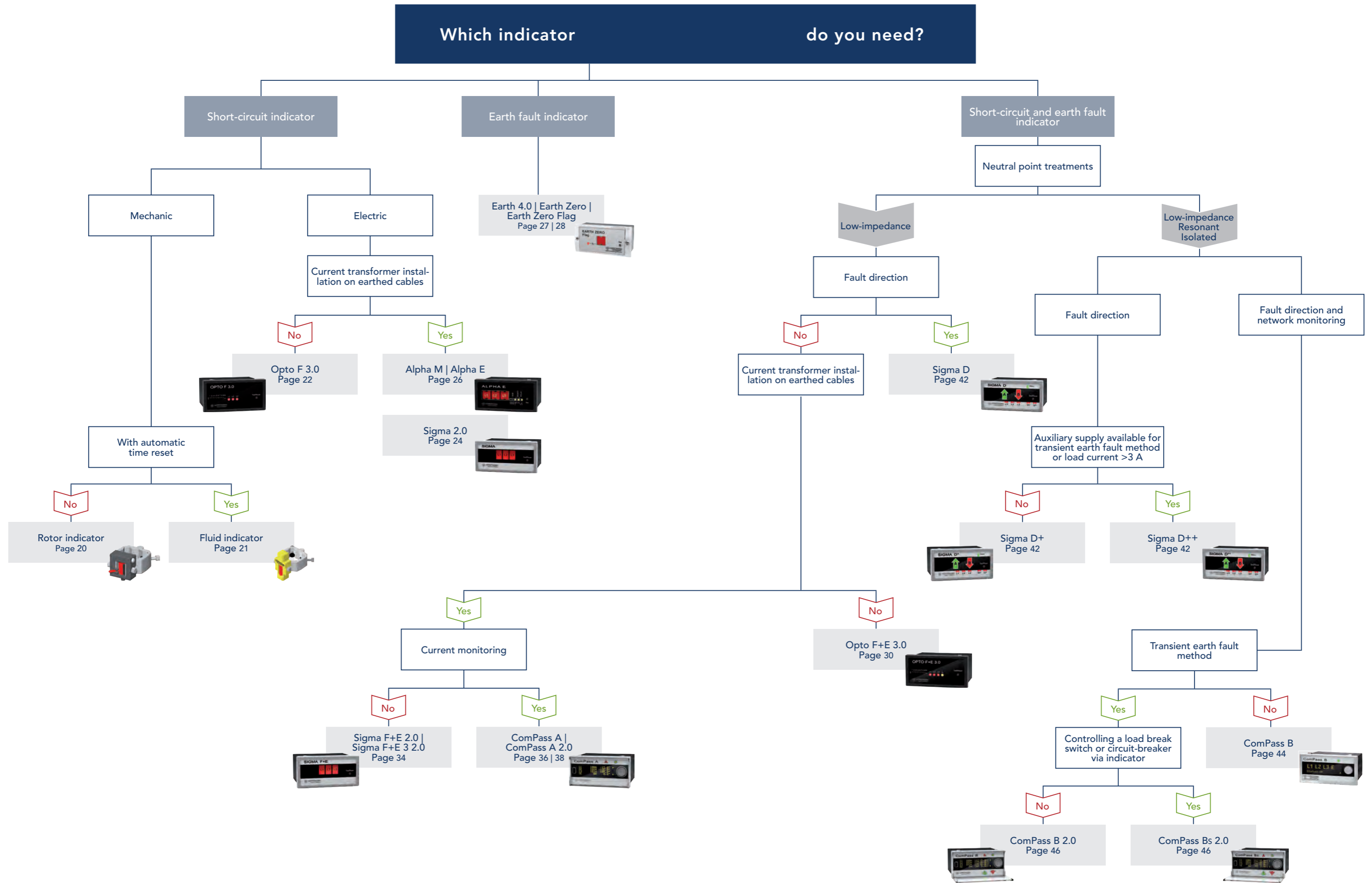

Product matrix

Short-circuit indicators



Function	Rotor indicator Page 20	Fluid indicator Page 21	Opto F 3.0 Page 22	Sigma 2.0 Page 24	Alpha M / Alpha E Page 26
Short-circuit indication/ earth short-circuit indication	■	■	■	■	■
Earth fault indication	-	-	-	-	-
Directional indication	-	-	-	-	-
Monitoring	-	-	-	-	-
Control function and programmable logic	-	-	-	-	-
Neutral System					
Low-impedance earthed/ short-term low-impedance earthed	■	■	■	■	■
Isolated earthed	-	-	-	-	-
Resonant earthed (with Petersen coil)	-	-	-	-	-
Earth fault detection methods					
IE> Earth fault trip current	-	-	■	-	-
IEP> Active residual current cos φ	-	-	-	-	-
IEQ> Reactive current sin φ	-	-	-	-	-
IET> Transient earth fault method	-	-	-	-	-
UNE> Neutral point displacement voltage (permanent earth fault)	-	-	-	-	-
Reset					
Manual	■	-	■	■	M: ■ E: ■
Remote	-	-	■	■	M: - E: ■
Automatic time reset	-	■	■	■	M: - E: ■
Current restoration	-	-	-	-	AC/DC: -
Voltage restoration	-	-	-	-	-
Auxiliary supply restoration	-	-	■	-	■
Test					
Manual	-	-	■	■	■
Remote	-	-	■	■	-
Communication					
Relay contacts	on request	on request	1	1	1
RS485/Modbus-RTU	-	-	-	-	-
USB port	-	-	-	-	-
Parameter setting					
Manual/remote/software via USB	-	-	■/-/-	■/-/-	■/-/-
Power supply					
Long-life lithium cell/capacitor	-	-	■	■/-	■ (E)
CT powered	■	■	-	■	■
External auxiliary supply	-	-	■	-	■
Number of current transformers (CT)/current sensor (S)					
Phase current/summation current	-	-	3/- (CT)	3/- (S)	3/- (CT)
Voltage coupling					
Capacitive/resistive	-	-	-	-	-

Product matrix

Earth fault indicators



Function	Earth 4.0 Page 27	Earth Zero (Type Flag) Page 28
Short-circuit indication/ earth short-circuit indication	-	-
Earth fault indication	■	■
Directional indication	-	-
Monitoring	-	-
Control function and programmable logic	-	-
Neutral System		
Low-impedance earthed/ short-term low-impedance earthed	■	■
Isolated earthed	■	■
Resonant earthed (with Petersen coil)	-	-
Earth fault detection methods		
IE> Earth fault trip current	■	■
IEP> Active residual current cos φ	-	-
IEQ> Reactive current sin φ	-	-
IET> Transient earth fault method	-	-
UNE> Neutral point displacement voltage (permanent earth fault)	-	-
Reset		
Manual	■	■
Remote	■	-
Automatic time reset	■	■
Current restoration	-	-
Voltage restoration	■	■
Auxiliary supply restoration	-	-
Test		
Manual	■	■
Remote	■	-
Communication		
Relay contacts	3	1
RS485/Modbus-RTU	-	-
USB port	-	-
Parameter setting		
Manual/remote/software via USB	■/-/-	■/-/-
Power supply		
Long-life lithium cell/capacitor	■	■
CT powered	■	■
External auxiliary supply	-	-
Number of current transformers (CT)/current sensor (S)		
Phase current/summation current	-/1 (CT)	-/1 (CT)
Voltage coupling		
Capacitive/resistive	-	-

Product matrix

Short-circuit and earth fault indicators



Function	Opto F+E 3.0 Page 30	Sigma plus Page 32	Sigma F+E 2.0 Page 34	Sigma F+E 3 2.0 Page 34
Short-circuit indication/ earth short-circuit indication	■	■	■	■
Earth fault indication	■	■	■	■
Directional indication	-	-	-	-
Monitoring	-	-	-	-
Control function and programmable logic	-	-	-	-
Neutral System				
Low-impedance earthed/ short-term low-impedance earthed	■	■	■	■
Isolated earthed	-	-	■	■
Resonant earthed (with Petersen coil)	-	-	-	-
Earth fault detection methods				
IE> Earth fault trip current	■	■	■	■
IEP> Active residual current cos φ	-	-	-	-
IEQ> Reactive current sin φ	-	-	-	-
IET> Transient earth fault method	-	-	-	-
UNE> Neutral point displacement voltage (permanent earth fault)	-	-	-	-
Reset				
Manual	■	■	■	■
Remote	■	■	■	■
Automatic time reset	■	■	■	■
Current restoration	-	■ AC/DC: ■	- AC/DC: -	■ AC/DC: ■
Voltage restoration	-	-	-	-
Auxiliary supply restoration	■	-	■	-
Test				
Manual	■	■	■	■
Remote	■	■	■	■
Communication				
Relay contacts	2	2	2	3
RS485 / Modbus-RTU	-	-	-	-
USB port	-	-	-	-
Parameter setting				
Manual/remote/software via USB	■/-/-	■/-/-	■/-/-	■/-/-
Power supply				
Long-life lithium cell/capacitor	■	■	■/- AC/DC: -/■	■/- AC/DC: -/■
CT powered	-	■ AC/DC: -	■ AC/DC: -	■ AC/DC: -
External auxiliary supply	■	- AC/DC: ■	- AC/DC: ■	- AC/DC: ■
Number of current transformers (CT)/current sensor (S)				
Phase current/summation current	3/1 (CT)	3/- or 2/1 (CT)	3/- (S)	3/- (S)
Voltage coupling				
Capacitive/resistive	-	-	-	-



ComPass A Page 36	ComPass A 2.0 Page 38
■	■
■	■
-	-
■	■
-	-
Neutral System	
■	■
■	■
-	■
Earth fault detection methods	
■	■
-	-
-	-
-	-
-	-
Reset	
■	■
■	■
■	■
■	■
-	-
-	■
Test	
■	■
■	■
Communication	
4	4
■	■
-	■
Parameter setting	
■/■/-	■/■/■
Power supply	
■	■
-	-
■	■
Number of current transformers (CT)/current sensor (S)	
3/- (S)	3/- (S)
Voltage coupling	
-	-

Product matrix

Directional fault indicators



Function	Sigma D Page 42	Sigma D+ Page 42	Sigma D++ Page 42
Short-circuit indication/ earth short-circuit indication	■	■	■
Earth fault indication	■	■	■
Directional indication	■	■	■
Monitoring	-	-	-
Control function and programmable logic	-	-	-
Neutral System			
Low-impedance earthed/ short-term low-impedance earthed	■	■	■
Isolated earthed	■	■	■
Resonant earthed (with Petersen coil)	-	■	■
Earth fault trip current values			
IE> Earth fault trip current	■	■	■
IEP> Active residual current cos φ	-	■	■
IEQ> Reactive current sin φ	-	■	■
IET> Transient earth fault method	-	■	■
UNE> Permanent earth fault (neutral point displacement voltage)	-	-	-
Reset			
Manual	■	■	■
Remote	■	■	■
Automatic time reset	■	■	■
Current restoration	■	■	■
Voltage restoration	■	■	■
Auxiliary supply restoration	-	-	-
Test			
Manual	■	■	■
Remote	■	■	■
Communication			
Relay contacts	4	4	4
RS485 / Modbus-RTU	-	-	-
USB port	■	■	■
Parameter setting			
Manual/remote/software via USB	■/-/■	■/-/■	■/-/■
Power supply			
Long-life lithium cell	■	■	■
CT powered	■	■	■ (not IET>)
External auxiliary supply	-	possible	■ (for IET>)
Number of current sensor			
Phase current/summation current	3/-	3/1	3/-
Voltage coupling			
Capacitive/resistive	■/-	■/-	■/-

Product matrix

Directional fault indicators with monitoring



Function	ComPass B Page 44	ComPass B 2.0 Page 46	ComPass Bs 2.0 Page 46
Short-circuit indication/ earth short-circuit indication	■	■	■
Earth fault indication	■	■	■
Directional indication	■	■	■
Monitoring	■	■	■
Control function and programmable logic	-	-	■
Neutral System			
Low-impedance earthed/ short-term low-impedance earthed	■	■	■
Isolated earthed	■	■	■
Resonant earthed (with Petersen coil)	■	■	■
Earth fault trip current values			
IE> Earth fault trip current	■	■	■
IEP> Active residual current cos φ	■	■	■
IEQ> Reactive current sin φ	■	■	■
IET> Transient earth fault method	-	■	■
UNE> Permanent earth fault (neutral point displacement voltage)	■	■	■
Reset			
Manual	■	■	■
Remote	■	■	■
Automatic time reset	■	■	■
Current restoration	■	■	■
Voltage restoration	■	■	■
Auxiliary supply restoration	■	■	■
Test			
Manual	■	■	■
Remote	■	■	■
Communication			
Relay contacts	4	4	4
RS485 / Modbus-RTU	■	■	■
USB port	-	■	■
Parameter setting			
Manual/remote/software via USB	■/■/-	■/■/■	■/■/■
Power supply			
Long-life lithium cell	■	■	■
CT powered	-	-	-
External auxiliary supply	■	■	■
Number of current sensor			
Phase current/summation current	2/1, opt. 3/- for IE> 10 A	3/-	3/-
Voltage coupling			
Capacitive/resistive	■/-	■/■	■/■

Rotor indicator

Short-circuit indicator

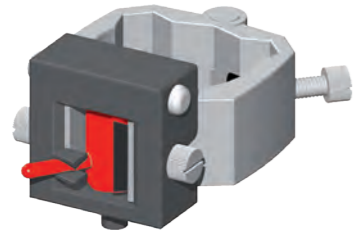

Rotor indicator

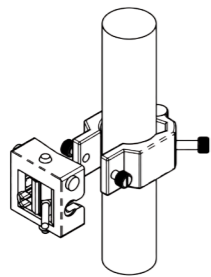

Installation

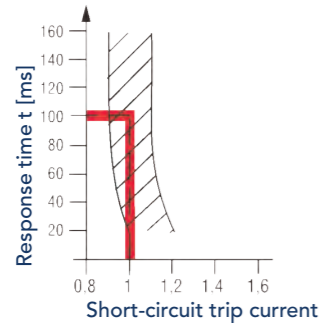

Response characteristic

Product features

- Mechanical design
- Installation on cables or busbars
- Fault indication by pivoted rotor
- Retrofit ready

Your advantages

- Universal use
- Reliable fault detection during re-energising
- Maintenance-free, no battery

The rotor indicator is a mechanical short-circuit indicator. It is designed to detect short-circuit currents in medium voltage distribution networks.

The indicator is tripped by a magnetic field strength "H" which is induced by trip values $I >>$. The pivoted rotor with reset pin uses a two-colour indication to inform the user of the state of the Rotor Indicator. "Black" means that the indicator has not been tripped whereas "red" indicates that the indicator has been tripped.

Technical data	Rotor indicator
$I >>$ Short-circuit trip current	150–2,000 A (factory setting)
$tI >>$ Response delay	100 ms at rated trip value
Accuracy	±10 %
Reset	Manual reset with hot stick
Material	<ul style="list-style-type: none"> ■ Housing and fixing screws made from polyamide ■ Yoke made from ferromagnetic steel
Temperature range	–40 to +85 °C

Dimension drawing see on page 158, M1

I_{min} [A]	for \varnothing [mm]	Order no.	Accessories	Page
150	8–16	20-0101-001 ¹⁾	Hot stick	151
200	16–20	20-0102-001		
200	20–30	20-0103-001		
200	30–40	20-0104-001		
200	40–50	20-0105-001		
300	50–60	20-0106-001		
300	60–80	20-0108-001		
I_{min} [A]	for \square [mm]	Order no.		
150	20 x 4–25 x 6	20-0122-001 ¹⁾		
150	25 x 4–30 x 6	20-0123-001 ¹⁾		
200	30 x 4–40 x 10	20-0120-001 ¹⁾		
300	45 x 4–60 x 12	20-0121-001 ¹⁾		

¹⁾ Screws for fixing the conductor made of steel
Combined rotor/fluid type short-circuit indicators are available on request.
Product matrix on page 14

Fluid indicator

Short-circuit indicator

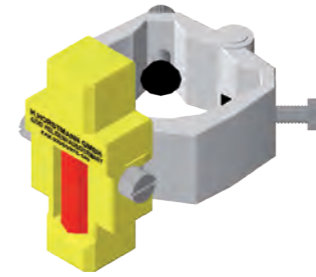

Fluid indicator

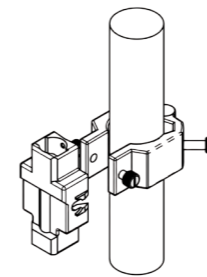

Installation

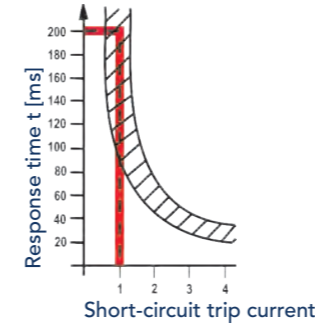

Response characteristic

Product features

- Mechanical design
- Installation on cables or busbars
- Fault indication by fluid with red coloured particles
- Retrofit ready

Your advantages

- Universal use
- Automatic reset
- Maintenance-free, no battery

The fluid indicator is a mechanical short-circuit indicator which is designed to detect short-circuit currents in medium voltage distribution networks.

The indicator is tripped by a magnetic field strength "H" which is induced by trip values $I >>$. When a short-circuit occurs, the mixer is pulled up by the magnetic field stirring up red particles in the fluid. The indication resets automatically after six to eight hours once the red particles have set to the bottom of the mixer.

Technical data	Fluid indicator
$I >>$ Short-circuit trip current	400, 600, 1,000 A (factory setting)
$tI >>$ Response delay	200 ms at rated trip value (100 ms are available on request)
Accuracy	±20 %
Reset	Automatic reset by time after approx. 6–8 h
Material	<ul style="list-style-type: none"> ■ Housing and fixing screws made from polyamide ■ Yoke made from ferromagnetic steel
Temperature range	–40 to +85 °C

Dimension drawing see on page 158, M2

I_{min} [A]	for \varnothing [mm]	Order no.
400	8–16	20-0401-000
400	16–20	20-0402-000
400	20–30	20-0403-000
400	30–40	20-0404-000
600	40–50	20-0405-000
600	50–60	20-0406-000
1,000	60–80	20-0408-000
I_{min} [A]	for \square [mm]	Order no.
400	30 x 4–40 x 10 ¹⁾	20-0420-000
400	20 x 4–25 x 6 ¹⁾	20-0422-000
400	25 x 4–30 x 6 ¹⁾	20-0423-000
600	45 x 4–60 x 12 ¹⁾	20-0421-000
I_{min} [A]	for \square [mm]	Order no.
400	30 x 4–40 x 15 ¹⁾	20-0410-000

¹⁾ Screws for fixing the conductor made of steel
Combined rotor/fluid type short-circuit indicators are available on request.
Product matrix on page 14

Opto F 3.0

Short-circuit indicator



Opto F 3.0, plug-in housing



Opto F 3.0, surface mount housing

Product features

- Fibre optic cables for electrical isolation between indicator and current transformers
- High-intensity LED indication
- Single and double flash mode for operation in radial and ring networks
- Remote indication via relay contact
- Current transformer retrofit ready

Your advantages

- Installation on bare cables and busbars
- New fault detection within reset time

The Opto F 3.0 is a short-circuit indicator. It is designed to detect, display and remotely indicate short-circuit currents in medium voltage distribution networks. The indicator unit can be used in all medium voltage switchgear installations. Fibre optic cables provide electrical isolation between the current transformers, mounted on cable/busbar, and the display unit when transferring signals.

The current transformers (CT) have an integrated trip threshold detection capability. When the pre-set trip current is reached or exceeded, light pulses will be emitted. A fibre optic cable is used to transmit these light pulses from the CT to the Opto. Phase-selectively operated red LEDs start flashing.

After the first tripping incident (e. g. in radial systems) the LEDs begin a phase-selective flash rhythm of: flash/pause/flash.

A second tripping (e. g. ring operated network with auto-reclosing) is indicated by flashing LEDs of the fault-affected phases in a flash-flash/pause/flash-flash rhythm.

Technical data	Opto F 3.0
Short-circuit indicator	■
I>> short-circuit trip current	400, 600, 800, 1,000 A ¹⁾ (adjustable at the CT)
tI>> response delay	40, 60, 80, 100, 200, 300, 500 ms (adjustable at the display unit)
Accuracy	±15 % (determined by current transformer)
Indication	Phase-selective short-circuit: 3 red LEDs, flashing period 2 s, double flash sequence 0.3 s with flashing period 3 s Optional: external signal lamp
Remote signal/communication	1 relay contact
Remote contact	Potential-free permanent or momentary contact Contact capacity: 380 V AC/5 A/1250 VA max.; 220 V DC/5 A/150 W max.
Reset	<ul style="list-style-type: none"> ■ By button ■ Automatic time reset: 1, 2, 4 or 8 h ■ Restoration of auxiliary supply ≥10 s (activated via DIP switch) ■ Remote reset
Power supply	<ul style="list-style-type: none"> Internal power supply: Long-life lithium cell, active flashing time >1,000 h, shelf life ≥20 years External auxiliary supply: 12–110 V DC ±10 % or 24–60 V AC (±10 %), 50–60 Hz (optional) Optional accessories: Transformer with cable for top-hat rail or screw mounting (115–230 V AC/24–48 V AC)
Housing	Polycarbonate, IP40 (plug-in housing), IP65 (surface mount housing)
Temperature range	–30 to +70 °C

1) Further trip currents on request.

Plug-in housing: dimension drawing see on page 158, M3

Surface mount housing: dimension drawing see on page 158, M6

Equipment set	Page	Accessories	Page
1 display unit		Cutting tool for fibre optic cables	57
Opto F 3.0, plug-in housing	Order no. 33-0513-001	Transformer for top-hat rail	57
Opto F 3.0, surface mount housing	Order no. 33-0613-001	External signal lamp	56
3 single-phase current transformers	49	Optical testing unit	57
3 fibre optic cables	57	Spring clip	57

Product matrix on page 14

Sigma 2.0

Short-circuit indicator



Sigma 2.0



Sigma 2.0 AC/DC

Product features

- Short-circuit indicator for all medium voltage networks
- Phase-selective fault indication
- Trip current values: load-dependent self-adjustment or fixed values
- Single and double flash mode for operation in radial and ring networks
- With auxiliary supply and capacitor storage available in AC/DC version

Your advantages

- No false trips due to higher harmonics
- Highly visible LED fault indication
- Retrofit ready for earth and short-circuit indicators with monitoring/control and fault direction function

The Sigma 2.0 is a phase-selective short-circuit indicator. It is designed to detect, display and remotely indicate short-circuits in medium voltage distribution networks.

The current is measured via three single-phase current sensors. By using the new sensors retrofit to more advanced indicator series is possible at any time – without changing the sensors.

There are two response criteria for short-circuit detection, fixed response value with response delay or auto-adjustment based on load current.

If the current for the selected response criterion – fixed value or self-adjustment – is exceeded, the fault-affected phase will be indicated by a bright flashing LED and remote contact will be activated. A double flashing LED signals a second fault that has occurred within the reset time, e. g. by an automatic reclose attempt and the remote contact will be reactivated.

For testing and commissioning purposes, the trip current values can be reduced to 10 A without changing the DIP switch settings.

Sigma 2.0 AC/DC

This version can be connected to auxiliary supply. If the auxiliary power drops out in the event of a fault, the LED indicator can operate using a back-up capacitor for up to 8 hours.

Technical data	Sigma 2.0
Short-circuit indicator	■
$I_{>>}$ short-circuit trip current	<ul style="list-style-type: none"> ■ 200, 300, 400, 600, 800, 1,000, 2,000 A ■ Self-adjustment to load current (I_L = load current): $I_L < 100 \text{ A} \Rightarrow I_{>>} = 400 \text{ A}$, $I_L > 100 \text{ A} \Rightarrow I_{>>} = 4 \times I_L$
$t_{I>>}$ response delay	40, 80 ms
Accuracy	5 % (0–630 A) 10 % (>630 A)
Indication	3 red LEDs: 3 x short-circuit (L1, L2, L3)
Remote signal/communication	1 potential-free relay contact
Remote contact	Potential-free permanent or momentary contact Contact capacity: 230 V AC/1 A/62.5 VA max.; 220 V DC/1 A/60 W max.
Reset	<ul style="list-style-type: none"> ■ By button ■ Automatic time reset: 1, 2, 4 or 8 h ■ Remote reset
Power supply	
CT powered	■
Internal power supply	Long-life lithium cell, active flashing time >900 h, shelf life ≥ 20 years AC/DC version: back-up capacitor, max. 8 h
External auxiliary supply	AC/DC version: 24–230 V AC/DC
Housing	Polycarbonate, IP40
Temperature range	–30 to +70 °C

Dimension drawing see on page 158, M3



Equipment set	Page	Accessories	Page
1 display unit		Connection to remote monitoring	77
Sigma 2.0	Order no. 37-1111-101	Wall-mounted housings	56
Sigma 2.0 AC/DC	Order no. 37-1121-101	External signal lamp	56
3 single-phase current sensors	50	Disassembly clip	57
		Spring clip	57

Product matrix on page 14

Alpha M | Alpha E

Short-circuit indicator



Alpha M



Alpha E

Product features

- Adjustable trip currents
- Flag-type indication (black/red)
- Remote signal
- No external power supply required

Your advantages

- Maintenance-free, no battery (Alpha M)
- Remote reset (Alpha E)

The Alpha M/Alpha E is designed to detect, display and remotely indicate short-circuit faults in medium voltage distribution networks.

The indication is tripped by a short-circuit current and remains active until the device is reset.

Technical data	Alpha M	Alpha E
Short-circuit indicator	■	■
I _{>>} short-circuit trip current	400, 600, 800, 1,000 A	
t _{I>>} response delay	100 ms, no tripping <20 ms	
Accuracy	±15 %	
Indication	3 display elements (black/red), bi-stable type, for L1, L2, L3	
Remote signal/communication	1 relay contact	
Remote contact	Potential-free permanent and momentary contact (>100 ms) Contact capacity: 230 V AC/1 A/62.5 VA max.; 220 V DC/1 A/60 A max.	
Reset	Via rotary knob	<ul style="list-style-type: none"> ■ By button ■ Remote reset: 12–60 V AC/DC ±10 % ■ Automatic time reset: 2 or 4 h
Power supply		
CT powered	■	■
Internal power supply	–	Long-life lithium cell, shelf life ≥20 years
Housing	Polycarbonate, IP40	
Temperature range	–30 to +70 °C	

Alpha M: dimension drawing see on page 158, M4
Alpha E: dimension drawing see on page 158, M3

Equipment set	Page	Accessories	Page
1 display unit		Wall-mounted housings	56
Alpha M	Order no. 30-1815-001	External signal lamp	56
Alpha E	Order no. 30-1715-001	Disassembly clip	57
3 single-phase current transformers	48	Spring clip	57

Earth 4.0

Earth fault indicator



Earth 4.0

Product features

- Indication of earth fault currents by LED and mechanical flag
- Remote indication, test and reset via relay contacts
- Battery status indication and remote indication via relay contact

Your advantages

- Clear earth fault indication via LED and mechanical flag
- Connection to remote monitoring
- Early warning of battery end-of-life

The Earth 4.0 is an earth fault indicator. It is designed to detect, locally indicate and remotely report earth fault currents in medium voltage distribution networks. A wired earth fault current transformer monitors the summation current of all three conductors. The electronics of the display unit evaluates the measurements. When the fault sensitivity threshold is exceeded, a red LED will start flashing and a mechanical flag becomes visible. In addition to that, the remote indication contacts are energised. A system-specific external signal lamp is optionally available.

Technical data	Earth 4.0
Earth fault indicator	■
I _{E>} earth fault trip current	25, 50, 60, 80 A ¹⁾
t _{I>} response delay	80, 160 ms ¹⁾
Accuracy	±10 %
Indication	<ul style="list-style-type: none"> ■ 1 red LED, flash rate 2 s ■ 1 yellow LED (battery status), flash rate 2 s ■ Mechanical flag
Remote signal/communication	<ul style="list-style-type: none"> ■ 2 relay contacts (change over) for earth fault indication ■ 1 relay contact (change over) for battery status indication
Remote contact	Potential-free permanent and momentary contact (1 s) Contact capacity: 230 V AC/1 A/62.5 VA max.; 220 V DC/1 A/60 A max.
Reset	<ul style="list-style-type: none"> ■ By button ■ Remote contact ■ Automatic time reset: 1, 2, 4 or 8 h ■ Voltage restoration (220–240 V AC, ≥10%)
Power supply	
CT powered	■
Internal power supply	Long-life lithium cell, shelf life ≥20 years, total flashing time ≥1,200 h
Housing	Polycarbonate, IP65
Temperature range	–30 to +70 °C

1) Further trip currents on request.
Dimension drawing see on page 158, M6

Equipment set	Page	Accessories	Page
1 display unit Earth 4.0	Order no. 32-0504-115	External signal lamp	56
3 summation current transformers	51		

Product matrix on page 15

Earth Zero | Earth Zero Flag

Earth fault indicator



Earth Zero, plug-in housing



Earth Zero, surface mount housing



Earth Zero Flag, plug-in housing



Earth Zero Flag, surface mount housing

Product features

- Indication of earth fault currents by LED and mechanical flag
- Remote indication

Your advantages

- LED for fast and clear indication
- Connection to remote monitoring
- Fault detection without opening/entering the substation

The Earth Zero is an earth fault indicator. It is designed to detect, locally indicate and remotely report earth fault currents in medium voltage distribution networks. A wired earth fault current transformer monitors the summation current of all three conductors. The electronics of the display unit evaluates the measurements. When the fault sensitivity threshold is exceeded, a red LED will start flashing and a mechanical flag becomes visible (Earth Zero Flag). In addition to that, the remote indication contacts are energised. A system-related external signal lamp (optionally available) is also activated.

Technical data	Earth Zero	Earth Zero Flag
Earth fault indicator	■	■
$I_{E>}$ earth fault trip current	25, 50, 75, 100 A ¹⁾	
$t_{I_{E>}}$ response delay	80, 160 ms ¹⁾	
Accuracy	±15 %	
Indication	1 red LED, flash rate 2 s	1 red LED, flash rate 2 s + mechanical flag
Remote signal/communication	1 relay contact and input for external signal lamp	
Remote contact	Potential-free permanent and momentary contact (1 s) Contact capacity: 230 V AC/1 A/62.5 VA max.; 220 V DC/1 A/60 A max.	
Reset	<ul style="list-style-type: none"> ■ By button ■ Automatic time reset: 2, 4 or 8 h ■ Voltage restoration (110–240 V AC) 	
Power supply	<ul style="list-style-type: none"> ■ CT powered ■ Internal power supply 	
	Long-life lithium cell, shelf life ≥20 years, total flashing time ≥1,200 h	
Housing	Polycarbonate, IP65	
Temperature range	–30 to +70 °C	

1) Further trip currents and/or response delays on request.
 Plug-in housing: dimension drawing see on page 158, M5
 Surface mount housing: dimension drawing see on page 158, M6

Equipment set	Page	Accessories	Page
1 display unit		External signal lamp	56
Earth Zero, plug-in housing	Order no. 32-0513-001		
Earth Zero, surface mount housing	Order no. 32-0503-001		
Earth Zero Flag, plug-in housing	Order no. 32-0512-002		
Earth Zero Flag, surface mount housing	Order no. 32-0502-002		
1 summation current transformer	51		

Product matrix on page 15

Opto F+E 3.0

Short-circuit and earth fault indicator



Opto F+E 3.0, plug-in housing



Opto F+E 3.0, surface mount housing

Product features

- Fibre optic cables for electrical isolation between indicator and current transformers
- High-intensity LED indication
- Single and double flash mode for operation in radial and ring networks
- Remote indication via relay contact
- Current transformer retrofit ready

Your advantages

- Installation on bare cables and busbars
- New fault detection within reset time

The Opto F+E 3.0 device is a combined short-circuit and earth fault indicator. It is designed to detect, display and remotely indicate short-circuit currents and earth faults in medium voltage distribution networks. The indicator unit can be used in all medium voltage switchgear installations. Fibre optic cables provide electrical isolation between the current transformers, mounted on cable/busbar, and the display unit when transferring signals. Due to its measuring principle, the earth fault indication is suitable for low-impedance or solidly earthed neutral networks as well as for radial or open ring networks.

The current transformers (CT) have an integrated trip threshold detection capability. When the pre-set trip current is reached or exceeded, light pulses will be emitted. A fibre optic cable is used to transmit these light pulses from the CT to the Opto. Phase-selectively operated red LEDs start flashing.

After the first tripping incident (e. g. in radial systems) the LEDs begin a phase-selective flash rhythm of: flash/pause/flash.

A second tripping (e. g. ring operated network with auto-reclosing) is indicated by flashing LEDs of the fault-affected phases in a flash-flash/pause/flash-flash rhythm.

Technical data	Opto F+E 3.0
Short-circuit indicator	■
Earth fault indicator	■
Earth fault detection method	Earth short-circuit
I>> short-circuit trip current	400, 600, 800, 1,000 A ¹⁾ (adjustable at the CT)
tI>> response delay	40, 60, 80, 100, 200, 300, 500 ms (adjustable at the display unit)
I> earth fault trip current	10, 20, 40, 80 A or 40, 80, 120, 160 A (adjustable at the CT)
tI> response delay	60, 100 or 200 ms (adjustable at the display unit)
Accuracy	±15 % (determined by current transformer)
Indication	Phase-selective short-circuit: 3 red LEDs, earth fault: 1 yellow LED, flashing period 2 s, double flash sequence 0.3 s with flashing period 3 s Optional: external signal lamp
Remote signal/communication	2 relay contact
Remote contact	Potential-free permanent or momentary contact Contact capacity: 380 V AC/5 A/1250 VA max.; 220 V DC/5 A/150 W max.
Reset	<ul style="list-style-type: none"> ■ By button ■ Automatic time reset: 1, 2, 4 or 8 h ■ Restoration of auxiliary supply ≥10 s (activated via DIP switch) ■ Remote reset
Power supply	
Internal power supply	Long-life lithium cell, active flashing time >1,000 h, shelf life ≥20 years
External auxiliary supply	12–110 V DC ±10 % or 24–60 V AC (±10 %), 50–60 Hz (optional)
Optional accessories	Transformer with cable for top-hat rail or screw mounting (115–230 V AC/24–48 V AC)
Housing	Polycarbonate, IP40 (plug-in housing), IP65 (surface mount housing)
Temperature range	–30 to +70 °C

1) Further trip currents on request.

Plug-in housing: dimension drawing see on page 158, M3

Surface mount housing: dimension drawing see on page 158, M6

Equipment set	Page	Accessories	Page
1 display unit		Cutting tool for fibre optic cables	57
Opto F+E 3.0, plug-in housing	Order no. 36-0323-001	Transformer for top-hat rail	57
Opto F+E 3.0, surface mount housing	Order no. 36-0313-001	External signal lamp	56
3 single-phase current transformers	49	Optical testing unit	57
1 summation current transformer	51	Disassembly clip	57
4 fibre optic cables	57	Spring clip	57

Product matrix on page 16



Sigma plus, plug-in housing



Sigma plus, surface mount housing



Sigma plus AC/DC, plug-in housing



Sigma plus AC/DC, surface mount housing

Product features

- Retrofit solution for old devices without replacing existing current transformers
- Can be adjusted to all common Horstmann current transformers
- Indication by high-intensity LEDs with a viewing angle of 180 degrees
- Load-dependent self-adjustment or fixed setting
- Single and double flash mode for operation in radial and ring networks

Your advantages

- Quick and easy upgrade of the switchgear
- Only replacement of the indicator necessary

The Sigma plus features all the functions provided by the Sigma and Sigma F+E devices thus capable of being used as a short-circuit indicator or as a combined short-circuit and earth fault indicator.

This device is ready for retrofit: Change or replace old indicators with the Sigma plus without replacing current transformers already existing in the switchgear.

The Sigma plus features a selection switch which is used to adapt the device to all current transformers.

Technical data	Sigma plus
Short-circuit indicator	■
Earth fault indicator	■
Earth fault detection method	Earth short-circuit
I>> short-circuit trip current	<ul style="list-style-type: none"> ■ (100), 200, 300, 400, 600, 800, 1,000 A ■ Self-adjustment to load current (I_L = load current): I_L < 100 A → I>> = 400 A, I_L > 100 A → I>> = 4 x I_L
tI>> response delay	40, 80, 200, 300 ms
I>E> earth fault trip current	20, 40, 60, 80, 100, 120, 160 A
tI>E> response delay	80, 160 ms
Accuracy	±15 %
Indication	Bright LED displays: <ul style="list-style-type: none"> ■ Short-circuit: 3 red phase-selective LEDs (L1, L2, L3) ■ Short-circuit / earth fault: 3 red LEDs (L1, E, L3)
Remote signal / communication	2 relay contacts
Remote contact	Potential-free permanent or momentary contact Contact capacity: 230 V AC / 1 A / 62.5 VA max.; 220 V DC / 1 A / 60 W max.
Reset	<ul style="list-style-type: none"> ■ By button ■ Automatic time reset: 2, 4, 8 or 24 h ■ Current restoration ■ Remote reset
Power supply	
CT powered	■
Internal power supply	Long-life lithium cell, active flashing time >1,000 h, shelf life ≥20 years
External auxiliary supply	AC/DC version: 24–230 V AC/DC
Housing	Polycarbonate, IP40 (plug-in housing), IP65 (surface mount housing)
Temperature range	–30 to +70 °C

Plug-in housing: dimension drawing see on page 158, M3
 Surface mount housing: dimension drawing see on page 158, M6

Equipment set	Page	Accessories	Page
1 display unit		Phase current transformers	48
Sigma plus, plug-in housing	Order no. 37-3110-001	Summation current transformer	48
Sigma plus, surface mount housing	Order no. 37-3510-001	Wall-mounted housings	56
Sigma plus AC/DC, plug-in housing	Order no. 37-3120-001	External signal lamp	56
Sigma plus AC/DC, surface mount housing	Order no. 37-3520-001	Disassembly clip	57
		Spring clip	57

Product matrix on page 16

Sigma F+E 2.0 | Sigma F+E 3 2.0

Short-circuit and earth fault indicator



Sigma F+E 2.0



Sigma F+E 2.0 AC/DC



Sigma F+E 3 2.0



Sigma F+E 3 2.0 AC/DC

Product features

- Short-circuit and earth fault detection from 3 single-phase current sensors
- Phase-selective fault indication
- Trip current values: load-dependent self-adjustment or fixed values
- Single and double flash mode for operation in radial and ring networks
- With auxiliary supply and capacitor storage available in AC/DC version

Your advantages

- No false trips due to higher harmonics
- Highly visible LED fault indication
- Detection of high-impedance earth faults
- Clear fault type indication via LED (Sigma F+E 3 2.0)
- Retrofit ready for earth and short-circuit indicators with monitoring/control and fault direction function

Sigma F+E 2.0 and Sigma F+E 3 2.0 are combined short-circuit and earth fault indicators. Due to the measuring principle the earth fault indication is suitable for low-impedance, solidly and isolated earthed neutral networks.

The current is measured via three single-phase current sensors. This allows phase-selective fault detection and indication.

There are two response criteria for short-circuit detection, fixed response values with response delay or auto-adjustment based on load current.

If the current for the selected response criterion – fixed value or self-adjustment – is exceeded, the fault-affected phase will be indicated by a bright flashing LED and remote contact will be activated. A double flashing LED signals a second fault that has occurred within the reset time, e. g. by an automatic reclose attempt and the remote contact will be reactivated.

For testing and commissioning purposes, the trip current values can be reduced to 10 A without changing the DIP switch settings.

Sigma F+E 3 2.0

Two additional LEDs display the fault type. The red LED I>> signals a short-circuit, the yellow LED I<E> signals an earth fault. The L1, L2 and L3 indication fields display the fault-affected phase. In addition, phase-selective (L1, L2, L3) or group-selective (I>>, I<E>, I>> and I<E>) remote signalling is possible.

Sigma F+E 2.0 AC/DC and Sigma F+E 3 2.0 AC/DC

These versions can be connected to auxiliary supply. If the auxiliary power drops out in the event of a fault, the LED indicator can operate using a back-up capacitor for up to 8 hours.

Technical data	Sigma F+E 2.0	Sigma F+E 3 2.0
Short-circuit indicator	■	
Earth fault indicator	■	
Earth fault detection method	Earth short-circuit	
I>> short-circuit trip current	<ul style="list-style-type: none"> ■ 200, 300, 400, 600, 800, 1,000, 2,000 A ■ Self-adjustment to load current (I_L=load current): I_L < 100 A → I>> = 400 A, I_L > 100 A → I>> = 4 × I_L 	
tI>> response delay	40, 80 ms	40, 80, 200, 300 ms
I<E> earth fault trip current	20, 40, 60, 80 100, 120, 160 A	
tI<E> response delay	80, 160 ms	60, 80, 200, 300 ms
Accuracy	5 % (0–630 A) 10 % (>630 A)	
Indication	3 red phase-selective LEDs: short-circuit 2 or 3 phases (L1, L2, L3) and earth fault 1 phase	LED indication <ul style="list-style-type: none"> ■ 3 red phase-selective LEDs L1, L2, L3 ■ 1 red LED short-circuit I>> ■ 1 yellow LED earth fault I<E>
Remote signal/communication	2 potential-free relay contact	3 potential-free relay contacts
Remote contact	Potential-free permanent or momentary contact Contact capacity: 230 V AC/1 A/62.5 VA max.; 220 V DC/1 A/60 W max.	
Reset	<ul style="list-style-type: none"> ■ By button ■ Automatic time reset: 1, 2, 4 or 8 h ■ Remote reset 	<ul style="list-style-type: none"> ■ By button ■ Automatic time reset: 1, 2, 4 or 8 h ■ Remote reset ■ Current restoration ■ Restoration of auxiliary supply (only AC/DC version)
Power supply	<ul style="list-style-type: none"> ■ CT powered ■ Internal power supply ■ External auxiliary supply 	
	Long-life lithium cell, active flashing time >900 h, shelf life ≥20 years AC/DC version: back-up capacitor, max. 8 h AC/DC version: 24–230 V AC/DC	
Housing	Polycarbonate, IP40	
Temperature range	–30 to +70 °C	

Dimension drawing see on page 158, M3



Equipment set	Page	Accessories	Page
1 display unit		Connection to remote monitoring	77
Sigma F+E 2.0	Order no. 37-2111-101	Wall-mounted housings	56
Sigma F+E 2.0 AC/DC	Order no. 37-2121-101	External signal lamp	56
Sigma F+E 3 2.0	Order no. 37-5113-101	Disassembly clip	57
Sigma F+E 3 2.0 AC/DC	Order no. 37-5123-101	Spring clip	57
3 single-phase current sensors	50		

Product matrix on page 16

ComPass A

Short-circuit and earth fault indicator



ComPass A

Product features

- Short-circuit and earth fault detection by 3 single-phase current sensors
- Phase-selective current monitor
- Multilingual OLED display, additional multicolour LED
- Remote indication via RS485/Modbus interface and 4 freely configurable relay contacts
- Simple and intuitive operation, easy-to-read display

Your advantages

- Network load visible on site
- Remote signalling of analogue values

The ComPass A device is a combined short-circuit and earth fault indicator for medium voltage distribution networks with solidly or low-impedance earthed neutral system.

The device indicates all measuring results and parameter settings on a menu-controlled display. Via Modbus protocol the device can be parameterised and reports the fault events and measured data to SCADA. Additionally 4 relay contacts for SCADA application are available.

When the previously set trip values are exceeded, the red LED will start flashing. By operating the rocker switch short-circuits or earth faults will be displayed in plain text format. The device saves the last 20 events along with date, time, and information on fault currents.

Technical data	ComPass A
Short-circuit indicator	■
Earth fault indicator	■
Earth fault detection method	Earth short-circuit
Measured values / indication	<ul style="list-style-type: none"> ■ Phase currents I₁, I₂, I₃, I_E with phase angle ■ Operating current, I₁, I₂, I₃, I_E \varnothing15 min, I₁, I₂, I₃ max. 24 h/7 days/365 days ■ Maximum demand indicator I max. LR (last reset) I₁, I₂, I₃ ■ Frequency f
I>> short-circuit trip current	10–2,000 A
tI>> response delay	40 ms–60 s
I>E> earth fault trip current	20–1,000 A
tI>E> response delay	40 ms–60 s
Measurement accuracy phase currents	<ul style="list-style-type: none"> 3 % (0–630 A, resolution 1 A) 5 % (630–1,500 A) 10 % (1,500–2,000 A)
Indication	<ul style="list-style-type: none"> ■ LED status display (multicolour) ■ OLED display (multicolour)
Remote signal / communication	<ul style="list-style-type: none"> ■ 4 potential-free relay contacts, freely configurable ■ RS485 / Modbus interface
Remote contact	4 potential-free permanent or momentary contacts (1 s), NC or NO Contact capacity: 230 V AC / 1 A / 62.5 VA max.; 220 V DC / 1 A / 60 W max.
Reset	<ul style="list-style-type: none"> ■ By rocker switch ■ Automatic time reset: 1 min–24 h ■ Remote reset ■ Via RS485 / Modbus interface ■ Current restoration
Power supply	
External auxiliary supply	24–230 V AC/DC (\pm 10 %)
Internal power supply	Long-life lithium cell, active flashing time >1,000 h, >1,000 display activations, shelf life \geq 20 years
Housing	Polycarbonate, IP40
Temperature range	–30 to +70 °C

Dimension drawing see on page 158, M3

Equipment set	Page	Accessories	Page
1 display unit ComPass A	Order no. 38-0102-001	Connection to remote monitoring	77
3 single-phase current sensors	50	Wall-mounted housings	56
		External signal lamp	56
		Disassembly clip	57
		Spring clip	57

Product matrix on page 16

ComPass A 2.0

Short-circuit and earth fault indicator with monitoring



ComPass A 2.0

Product features

- Short-circuit and earth fault indicator
- Suitable for all types of networks/neutral point treatments
- Earth fault detection with earth short-circuit and pulse detection method
- LEDs and OLED display: for good visibility
- High-precision current measurement to 0.5 %
- PT100 temperature sensor for equipment monitoring
- Monitoring of the parameters current (I), temperature (T) and frequency (f)
- Limit monitoring: I, T
- Compass Explorer Software: Commissioning and parameterisation via front accessible USB port

Your advantages

- Fast commissioning and parameterisation
- One indicator for all type of networks
- Retrofit ready for earth and short-circuit indicators with monitoring/control and fault direction function

The ComPass A 2.0 is suitable for use in substations with a remote control connection of the electrical power distribution in a medium voltage network. Trip current values and pre-fault current values are logged with time stamp.

In addition to the short-circuit and earth fault function, the ComPass A 2.0 measures the temperature, for example of a transformer or the transformer station with the PT100 sensor.

The ComPass A 2.0 provides the collected information, measured values and their limits, for transmission to the control room. Phase selectivity and faults (earth fault or short-circuit) are also shown in the OLED display.

Technical data	ComPass A 2.0
Short-circuit indicator	■
Earth fault indicator	■
Earth fault detection method	Earth short-circuit
Measured values / indication	<ul style="list-style-type: none"> ■ Phase currents I₁, I₂, I₃, I_E with phase angle ■ Operating current, I₁, I₂, I₃, all average values adjustable (1–60 min), I₁, I₂, I₃ max. 24 h/7 days/365 days, maximum demand indicator I_{max}. LR (last reset), T_{min}. LR, T_{max}. LR ■ Frequency f ■ Temperature T
I>> short-circuit trip current	10–2,000 A, self-adjustment
tI>> response delay	20 ms–60 s
IE> earth short-circuit trip current	10–1,000 A
tIE> response delay	40 ms–60 s
Limit monitoring	
I> overload current	5–1,500 A; tI> response delay: 40 ms–60 s
T</T<</T>/T>> temperature	-40 to +85 °C
Measurement accuracy phase currents	Up to 0.5 %/0.5 A closed sensor type, ≤1 %/0.5 A split-core sensor type
Indication	<ul style="list-style-type: none"> ■ LED status display (multicolour) ■ OLED display (multilingual)
Remote signal/communication	<ul style="list-style-type: none"> ■ 4 potential-free relay contacts, freely configurable ■ RS485/Modbus interface
Parameter setting	USB port with ComPass Explorer Software
Remote contact	4 potential-free permanent or momentary contacts, bistable, NC or NO Contact capacity: 230 V AC/1 A/62.5 VA max.; 220 V DC/1 A/60 W max.
Binary inputs	2, potential-free, 1 s < t < 5 s, freely programmable
Reset	<ul style="list-style-type: none"> ■ By rocker switch ■ Automatic time reset: 1 min–24 h ■ Remote reset ■ Via RS485/Modbus interface ■ Current restoration ■ Restoration of auxiliary supply ■ ComPass Explorer Software
Power supply	
External auxiliary supply	24–230 V AC/DC (±10 %)
Internal power supply	Long-life lithium cell, active flashing time >1,000 h, >1,000 display activations, shelf life ≥20 years
Housing	Polycarbonate, IP50
Temperature range	-30 to +70 °C

Dimension drawing see on page 159, M7



Equipment set	Page	Accessories	Page
1 display unit ComPass A 2.0	Order no. 38-0152-001	Connection to remote monitoring	77
3 single-phase current sensors	50	Wall-mounted housings	56
		Temperature sensor PT100	57
		External signal lamp	56
		Disassembly clip	57
		Spring clip	57

Product matrix on page 16

Equipment set options

For directional fault indicators Sigma D series and ComPass B series

Voltage signal

HR Jack module	Gas-/solid insulated switchgear	Air-insulated switchgear
 HR interface cable Page 110	 Wega with HR interface cable Page 110	 Integrated voltage detecting system Wega series Page 100
 Interface cable Page 111	 Wega with interface cable Page 111	

+

Current signal

 Split-core single-phase current sensors for retrofit and new installations Page 50	 Closed single-phase current sensors for new installations Page 50
--	---

+

Directional short-circuit and earth fault indicators

 Sigma D series Page 42	 ComPass B series Page 44 + 46
--------------------------------------	---

[+]

Resistive voltage signal

 Optional supplement Page 55

Project planning

For directional fault indicators Sigma D series and ComPass B series

Company Contact partner Phone

Project

Network information

Operating voltage V_{Nom} kV Neutral point treatment

Switchgear

Manufacturer Type Year of construction Panel name

<input type="checkbox"/> Gas-insulated/solid insulated	<input type="checkbox"/> Air insulated
<input type="checkbox"/> C1 capacity <input type="text"/> pF or panel type <input type="text"/>	<input type="checkbox"/> C1 capacity <input type="text"/>
<input type="checkbox"/> Resistive voltage coupling	Type of post insulator <input type="text"/>
Set of connectors <input type="text"/>	<input type="checkbox"/> Post insulator has to be supplied cable length <input type="text"/> m

Voltage signal

Gas-/solid/air-insulated switchgear	Air-insulated switchgear
Systems solution – Wega <input type="checkbox"/> Wega 1.2 C <input type="checkbox"/> Wega 1.2 C vario <input type="checkbox"/> Wega 2.2 C	Systems solution – Wega to HR interface <input type="checkbox"/> Wega 1.2 C vario
Direct connection – HR interface <input type="checkbox"/> HR interface cable	Direct connection – capacitive post insulator <input type="checkbox"/> Interface cable for capacitive post insulators

Cable length between voltage signal and Sigma/ComPass m

Directional fault indicator

<input type="checkbox"/> Sigma D <input type="checkbox"/> Sigma D ⁺¹ <input type="checkbox"/> Sigma D ⁺⁺	<input type="checkbox"/> ComPass B <input type="checkbox"/> ComPass B 2.0 <input type="checkbox"/> ComPass Bs 2.0
--	---

Cable length between Sigma/ComPass and current signal m

Current signal

<input type="checkbox"/> Single-phase current sensor for retrofit on insulated cables	<input type="checkbox"/> Single-phase current sensor for new installations on bushings
---	--

Your comments

1) We recommend the use of an additional summation current sensor for the transient earth fault method.

Sigma D | Sigma D+ | Sigma D++

Directional fault indicator



Sigma D



Sigma D+



Sigma D++

Product features

- CT powered directional short-circuit and directional earth fault indicator for all distribution networks/neutral point treatments
- Earth fault detection with up to five different earth fault detection methods, also in combination
- Fully automatic voltage calibration
- Easy and flexible parameter setting via DIP switch or USB port
- Event memory for fault evaluation
- Multicolour LED status display
- Remote signalling via freely programmable relays
- Sigma Explorer Software: Commissioning and parameterisation via front accessible USB port

Special features of Sigma D++

- Only 3 single-phase current sensors needed for all earth fault detection methods
- Wide-range power supply 24 to 230 V AC/DC

Your advantages

- Immediate detection of fault direction
- No auxiliary supply required
- Fast commissioning and parameterisation
- Monitoring on site with USB and notebook

The Sigma D series are combined directional short-circuit and directional earth fault indicators for medium voltage distribution networks. The devices are current sensor powered. The voltage information will be taken from an integrated voltage detecting system (Wega series), from an HR interface or capacitive post insulators.

The Sigma D+ and Sigma D++ provide additional earth fault detection methods for compensated and isolated neutral networks.

The variants differ in regard of the transient earth fault method.

Sigma D+

For the transient earth fault method with the Sigma D+ a summation current sensor is mandatory, auxiliary supply is optional.

Sigma D++

For the transient earth fault method only three single-phase current sensors are needed, but auxiliary supply is mandatory. The connection of a summation current sensor is optional. For all other methods no auxiliary supply is needed.

Technical data	Sigma D	Sigma D+	Sigma D++
Directional short-circuit indicator	■	■	■
Directional earth fault indicator	■	■	■
Earth fault detection methods	Earth short-circuit	Transient, earth short-circuit, $\cos \varphi$ or $\sin \varphi$	
I>> short-circuit trip current	<ul style="list-style-type: none"> ■ DIP: 200, 300, 400, 600, 800, 1,000, 2,000 A, self-adjustment ■ SW: 50–2,000 A (1 A steps) 		
tI>> response delay	<ul style="list-style-type: none"> ■ DIP: 40, 80 ms ■ SW: 40 ms–60 s 		
I>E> earth fault trip current	<ul style="list-style-type: none"> ■ DIP: off, 20, 40, 60, 80, 100, 120, 160 A ■ SW: 20–1,000 A (1 A steps) 		
tI>E> response delay	<ul style="list-style-type: none"> ■ DIP: 80, 160 ms ■ SW: 40 ms–60 s 		
Measurement accuracy phase currents	<ul style="list-style-type: none"> 3 % (0–630 A, resolution 1 A) 5 % (630–1,500 A) 10 % (1,500–2,000 A) 		
I>ET> Transient method, trip current	–	10–100 A	10–500 A
I>EP> Active current $\cos \varphi$ trip current	–	5–200 A	
tI>EP> response delay		40 ms–60 s	
I>EQ> Reactive current $\sin \varphi$ trip current	–	5–200 A	
tI>EQ> response delay		40 ms–60 s	
Indication	LED fault direction arrows red/green		
Remote signal/communication	4 potential-free relay contacts, freely configurable		
Remote contact	Potential-free permanent or momentary contacts (1 s), NC or NO Contact capacity: 230 V AC/1 A/62.5 VA max.; 220 V DC/1 A/60 W max.		
Reset	<ul style="list-style-type: none"> ■ By button ■ Automatic time reset: DIP: 2, 4, 8 or 24 h; SW: 1 min–24 h ■ Remote reset ■ Current and voltage restoration 		
Voltage calibration	Manual/automatic		
Power supply			
CT powered	■	■	■
Internal power supply	Long-life lithium cell, active flashing time >900 h, shelf life ≥ 20 years		
External auxiliary supply	–	24 V AC/24–60 V DC (optional)	24–230 V AC/DC (optional) required for transient method
Summation current sensor	–	Required for transient method	Optional
Housing	Polycarbonate, IP40		
Temperature range	–30 to +70 °C		

Dimension drawing see on page 158, M3



Equipment set	Page	Accessories	Page
1 display unit Sigma D	Order no. 37-6000-001	Installation system	57
3 single-phase current sensors	50	Connection to remote monitoring	78
1 voltage signal	52	Wall-mounted housings	56
Equipment set	Page	External signal lamp	56
1 display unit Sigma D+	Order no. 37-6100-001	Disassembly clip	57
3 single-phase current sensors	50	Spring clip	57
1 summation current sensor (required for transient method)	51		
1 voltage signal	52		
Equipment set	Page		
1 display unit Sigma D++	Order no. 37-6200-001		
3 single-phase current sensors ¹⁾	50		
1 voltage signal	52		

1) Combination with summation current sensor possible: 3+1
Project planning on page 41
Product matrix on page 18

ComPass B

Directional fault indicator with monitoring



ComPass B

Product features

- Directional short-circuit and directional earth fault detection for all distribution networks/neutral point treatments
- Monitoring of V, I, f
- Load monitoring and load flow direction monitoring P, Q, S, cos φ, E
- Voltage monitoring V<, V>
- Active energy to load flow direction A↑ or B↓
- Multilingual OLED display, additional multicolour LED
- Remote indication using RS485/Modbus interface and four freely configurable relay contacts
- User friendly, simple and intuitive operation, easy-to-read display

Your advantages

- Fast fault location determination
- Immediate detection of voltage limit violations
- Measured values available for SCADA and on site

The ComPass B combines the functions of a directional short-circuit and directional earth fault indicator in one unit for medium voltage distribution networks. The voltage information will be taken from the integrated voltage detecting system, either Wega 1.2 C, Wega 2.2 C or Wega 1.2 C vario. Optional the voltage information can be taken from the HR interface or capacitive post insulators.

Technical data	ComPass B
Directional short-circuit indicator	■
Directional earth fault indicator	■
Earth fault detection methods	Permanent, earth short-circuit, cos φ, sin φ
Measured values / indication	<ul style="list-style-type: none"> ■ Phase currents I₁, I₂, I₃, I_E with phase angle ■ Phase-to-earth voltage V₁, V₂, V₃, V_{NE} and phase-to-phase voltage V₁₂, V₂₃, V₃₁, V_{NE} ■ Load flow direction A↑ or B↓ ■ S, P, Q and cos φ (S_{1,2,3}, P_{1,2,3}, Q_{1,2,3}, cos φ_{1,2,3}) ■ Effective energy (E_{1A}, E_{2A}, E_{3A}, E_A, E_{1B}, E_{2B}, E_{3B}, E_B) ■ Operating current, I₁, I₂, I₃, I_E ø15 min, I₁, I₂, I₃ max. 24 h/7 days/365 days ■ Maximum demand indicator I max. LR (last reset) I₁, I₂, I₃ ■ Frequency f
I>> short-circuit trip current	20–2,000 A
tI>> response delay	40 ms–60 s
I<E> earth fault trip current	20–1,000 A (low-impedance/solidly earthed network) 5– 200 A (isolated/compensated network)
tI<E> response delay	40 ms–60 s
I<E>P> active current cos φ	1–200 A
tI<E>P> response delay	40 ms–60 s
I<E>Q> reactive current sin φ	1–200 A
tI<E>Q> response delay	40 ms–60 s
V<E> permanent earth fault values	0–100 %
tV<E> response delay	40 ms–60 s
V> overvoltage trip values	100 %–200 %
V< undervoltage trip values	0 %–100 %
Measurement accuracy phase currents	3 % (0–630 A, resolution 1 A) 5 % (630–1,500 A) 10 % (1,500–2,000 A)
Indication	<ul style="list-style-type: none"> ■ LED status display (multicolour) ■ OLED display (multicolour)
Remote signal/communication	<ul style="list-style-type: none"> ■ 4 potential-free relay contacts, freely configurable ■ RS485/Modbus interface
Remote contact	4 potential-free permanent or momentary contacts (1 s), NC or NO Contact capacity: 230 V AC/1 A/62.5 VA max.; 220 V DC/1 A/60 W max.
Reset	<ul style="list-style-type: none"> ■ By rocker switch ■ Automatic time reset: 1 min–24 h ■ Remote reset ■ Via RS485/Modbus interface ■ Current restoration ■ Restoration of auxiliary supply ■ Voltage restoration
Power supply	
External auxiliary supply	24–230 V AC/DC (±10 %)
Internal power supply	Long-life lithium cell, active flashing time >1,000 h, >1,000 display activations, shelf life ≥20 years
Housing	Polycarbonate, IP40
Temperature range	–30 to +70 °C

Dimension drawing see on page 158, M3



Equipment set	Page	Accessories	Page
1 display unit ComPass B	Order no. 38-4102-001	Installation system	57
3 single-phase current sensors ¹⁾	50	Connection to remote monitoring	78
1 voltage signal	52	Wall-mounted housings	56
		External signal lamp	56
		Disassembly clip	57
		Spring clip	57

1) Combination with summation current sensor possible: 2+1 (for resonant earthed neutral systems).
Project planning on page 41
Product matrix on page 19

ComPass B 2.0 | ComPass Bs 2.0

Directional fault indicator with monitoring and control function



ComPass Bs 2.0

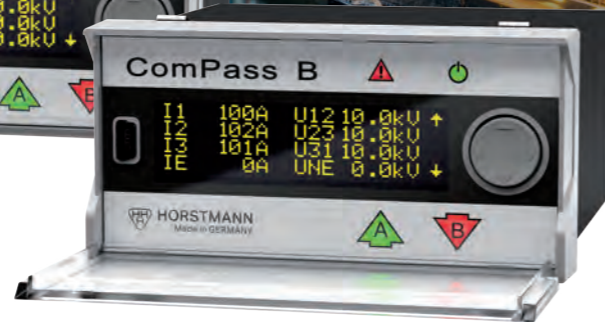

ComPass B 2.0

Product features

- Clear fault indication and reading on-site: 2 directional arrow LEDs (A, B) and high contrast OLED display
- High-precision current and voltage measurement to 0.5 %
- Monitoring of the parameters voltage (V), current (I), load flow direction (A↑ or B↓), power factor (cos φ), power (P, Q, S), energy (E), temperature (T) and frequency (f)
- Suitable for all types of networks/neutral point treatments
- Earth fault detection with 6 different earth fault detection methods, also in combination
- Voltage monitoring with connection to capacitive and resistive (ohmic) sensors in one indicator
- Limit monitoring: V, I, P, Q, T
- ComPass Explorer Software: Commissioning and parameterisation via front accessible USB port

Additional features of the Control ComPass Bs 2.0:

- Control ComPass Bs 2.0 for remote controlling of a load-break switch or circuit-breaker
- Free assignment of six binary inputs for the collection and transmission of relevant switchgear/station data
- Freely programmable logic for flexible definition of switchgear conditions

Your advantages

- Immediate detection of fault direction
- Immediate detection of limit violations
- Measured values available for SCADA and on site
- Automatic self-calibration of the capacitive voltage inputs, optionally with temperature compensation
- Only ComPass Bs: Remote switching

The ComPass B 2.0 is suitable for use in substations with a remote control connection of the electrical power distribution in a medium voltage network. In addition to the short-circuit and earth fault function, ComPass B 2.0 supplies the collected measured values of current, voltage and power from the station for transmission to the control room. The PT-100 sensor measures the temperature, for example of the transformer or the transformer station. For all measured values limits can be defined, which can also be transmitted to the control room.

The voltage coupling/measurement is done via the capacitive VDS system and/or via resistive (ohmic) voltage sensors. With the simultaneous measurement, the voltage measurement of the VDS system can be automatically calibrated with the resistive voltage measurement. Up to four ComPass B can be connected to one set of resistive voltage sensors.

In addition to the functions of the ComPass B 2.0, the Control ComPass Bs 2.0 offers a control function for switching a load-break switch or circuit-breaker. A free assignment of six binary inputs in combination with a freely programmable logic (PLC functionality) enables the user to define the switching conditions in a flexible manner. Random information, such as the SF6 gas disruption or HV tripped fuse, can be captured via the binary inputs.

Technical data	ComPass B 2.0	ComPass Bs 2.0
Directional short-circuit indicator	■	■
Directional earth fault indicator	■	■
Earth fault detection methods	Permanent, earth short-circuit, transient, cos φ, sin φ	
Control system / freely programmable logic	–	■
Measured values / indication	<ul style="list-style-type: none"> Phase currents I₁, I₂, I₃, I_E with phase angle Phase-to-earth voltage V₁, V₂, V₃, V_{NE} and phase-to-phase voltage V₁₂, V₂₃, V₃₁, V_{NE} Load flow direction A↑ or B↓ P, Q, S and cos φ (power factor) (P_{1,2,3}, Q_{1,2,3}, S_{1,2,3}, cos φ_{1,2,3} via RS485) Amount of active energy, separate for load flow direction A↑ or B↓, additionally per phase Operating current, I₁, I₂, I₃, I_E, S, P, Q, U₁₂, U₂₃, U₃₁, all average values adjustable (1–60 min), I₁, I₂, I₃ max. 24 h/7 days/365 days, maximum demand indicator I_{max}, LR, V_{12max}, LR, V_{23max}, LR, V_{31max}, LR, S_{max}, LR, P_{max}, LR, Q_{max}, LR, T_{min} LR, T_{max}, LR (last reset) Power frequency f Temperature T 	
I>> short-circuit trip current	20–2,000 A, self-adjustment	tI>> response delay: 20 ms–60 s
IES>/IES>> earth short-circuit trip current	10–1,000 A	tIES>/tIES>> response delay: 40 ms–60 s
IE> transient method	1–500 A	
IEP> active current cos φ	1–200 A	tIEP> response delay: 40 ms–60 s
IEQ> reactive current sin φ	1–200 A	tIEQ> response delay: 40 ms–60 s
VNE> permanent earth fault values	1–100 %	tVNE> response delay: 40 ms–60 s
Limit monitoring		
I> overload current	5–1,500 A	tI> response delay: 40 ms–60 s
V> overvoltage	100–200 %	tV> response delay: 40 ms–60 s
V< undervoltage	1–100 %	tV< response delay: 40 ms–60 s
P>/P>>/+P>/–P> active power	1–30,000 kW	tP>/tP>>/+tP>/–tP> response delay: 40 ms–60 s
Q>/Q>>/+Q>/–Q> reactive power	1–30,000 kW	tQ>/tQ>>/+tQ>/–tQ> response delay: 40 ms–60 s
T</T<</T>/T>> temperature	–40 to +85 °C	
Measurement accuracy phase currents	Up to 0.5 %/0.5 A closed sensor type, ≤1 %/0.5 A split-core sensor type	
Measurement accuracy voltages	Up to 0.5 % in the range of 80–120 %/V _{nom} (resistive)	
Indication	<ul style="list-style-type: none"> LED status display (multicolour) OLED display (multicolour) 	
Binary inputs	2, potential-free, 1 s < t < 5 s, freely programmable	6, freely programmable, max. 30 V DC
Remote signal / communication	<ul style="list-style-type: none"> 4 potential-free relay contacts, freely configurable RS485 / Modbus interface 	
Parameter setting	USB port with ComPass Explorer Software	
Remote contact	4 permanent or momentary contacts, bistable, NC or NO Contact capacity: 230 V AC / 1 A / 62.5 VA max.; 220 V DC / 1 A / 60 W max.	4 permanent or momentary contacts, monostable, NC or NO Contact capacity: 250 V AC / 6 A; 30 V DC / 6 A, resistive load
Reset	<ul style="list-style-type: none"> By rocker switch Automatic time reset: 1 min–24 h Remote reset Via RS485 / Modbus interface Current restoration Restoration of auxiliary supply Voltage restoration ComPass Explorer Software 	
Power supply		
External auxiliary supply	24–230 V AC/DC (±10 %)	
Internal power supply	Long-life lithium cell, active flashing time >1,000 h, >1,000 display activations, shelf life ≥20 years	
Housing	Polycarbonate, IP50	
Temperature range	–30 to +70 °C	

Dimension drawing see on page 159, M7



Equipment set	Page	Accessories	Page
1 display unit		Installation system	57
ComPass B 2.0	Order no. 38-4150-001	Connection to remote monitoring	78
ComPass Bs 2.0	Order no. 38-4153-001	Temperature sensor PT100	57
3 single-phase current sensors ¹⁾	50	Wall-mounted housings	56
1 voltage signal	52	External signal lamp	56
		Disassembly clip	57
		Spring clip	57

1) Combination with summation current sensor possible: 2+1 or 3+1
Project planning on page 41, Product matrix on page 19

Phase current transformers

For installation on bushings and pole plates

for Alpha M, Alpha E, Sigma plus



ABB
Type:
SafeRing, RGC, SafeLink
SafePlus
Order no.
3 x 49-6012-009



ABB
Type:
SafeRing, RGC,
SafePlus
Order no. set
1 x 49-6012-015



Driescher
Type:
MINEX, G.I.S.E.L.A.
Order no.
3 x 49-6012-007



EATON/Holec
Type:
SVS
Order no. set
1 x 49-6010-032



EATON/Holec
Type:
XIRIA
Order no. set
1 x 49-6010-048



Ormazabal
Type:
ga, gae, ge
Order no.
3 x 49-6010-011



Schneider Electric
Type:
RM6
Order no.
3 x 49-6010-044



Schneider Electric
Type:
FBA, GLA, GMA
Order no.
3 x 49-6010-030



Schneider Electric
Type:
FBX cable-type CTs for pole
plate
Order no.
3 x 49-6012-005



Siemens
Type:
8DJ, 8DH, SIMOSEC
Order no.
3 x 49-6010-052



Siemens
Type:
8DJH (module transformer)
Order no.
3 x 49-6010-060

For installation on insulated cables

for Alpha M, Alpha E, Sigma plus



Conductor Ø [mm]	Cable length [m]	Order no.
15-52	3.00	49-6011-040
15-52	6.00	49-6011-043

For installation on medium voltage cables or bright copper bar

for Opto F 3.0, Opto F+E 3.0



Trip currents ¹⁾ [A]	Conductor Ø [mm]	Order no.
400, 600, 800, 1,000	22-42	49-0101-202

1) adjustable



Trip currents ¹⁾ [A]	Conductor Ø [mm]	Order no.
400, 600, 800, 1,000	40-60	49-0101-203

1) adjustable



Trip currents ¹⁾ [A]	Conductor □ [mm]	Order no.
400, 600, 800, 1,000	20 x 4-40 x 10	49-0101-206

1) adjustable

Single-phase current sensors

For new installations on bushings

for Sigma 2.0 series, Sigma D series, ComPass series



ABB
Type:
Safelink, SafePlus, SafeRing
Ø 79,5 mm / 84 mm
Order no.
3 x 49-6025-000 or
3 x 49-6025-301



Driescher
Type:
MINEX, MINEX C, G.I.S.E.L.A.
Ø 84 mm
Order no.
49-6025-601¹⁾



EATON
Type:
XIRIA
Ø 79,5 mm / 84 mm
Order no.
3 x 49-6025-000 or
3 x 49-6025-301



Lucy Electric
Type:
AegisPlus
Ø 84 mm
Order no.
3 x 49-6025-601



Ormazabal
Type:
ga, gae, ge
Ø 84 mm
Order no.
3 x 49-6025-311



Schneider Electric
Type:
RM6
Ø 84 mm
Order no.
3 x 49-6025-301



Schneider Electric
Type:
FBX
Ø 84 mm
Order no.
1 x 49-6025-622



Siemens
Type:
8DJH (cable panel)
Ø 84 mm
Order no.
1 x 49-6025-630



Siemens
Type:
NXPLUS C, Simosec World
Ø 84 mm
Order no.
3 x 49-6025-611

For screened connectors only. Insulation level: 0.72/3 kV.

1) Without retaining plates. Order no. with retaining plates on request

For retrofit on insulated cables

for Sigma 2.0 series, Sigma D series, ComPass series



Conductor Ø [mm]	Cable length [m]	Order no.
15-55	3.00	49-6024-001



Conductor [mm]	Cable length [m]	Order no.
15-65	3.00	49-6024-010
15-78 (1250 A)	3.00	49-6024-130

Summation current transformers

For installation on insulated cables

for Sigma plus



Conductor Ø [mm]	Cable length [m]	Order no.
40-115	3.00	49-6013-016

Conductor [mm]	Cable length [m]	Order no.
280-50, oval	3.00	49-6013-028

Conductor [mm]	Cable length [m]	Order no.
350-50, oval	3.00	49-6013-027

For installation on medium voltage cables

for Earth Zero, Earth Zero Flag, Earth 4.0



Conductor Ø [mm]	Cable length [m]	Order no.
60-150	3.0	49-6013-029

For installation on medium voltage cables

for Opto F+E 3.0



Conductor Ø [mm]	Trip currents ¹⁾ [A]	Order no.
up to 115	40, 80, 120 or 160	49-6014-009
up to 115	(10), (20), 40 or 80	49-6014-007

Conductor Ø [mm]	Trip currents ¹⁾ [A]	Order no.
280 x 50, oval	80, 120, 160 or 200	49-6014-022

1) adjustable

Conductor Ø [mm]	Trip currents ¹⁾ [A]	Order no.
350 x 50, oval	80, 120, 160 or 200	49-6014-021

1) adjustable

Summation current sensors

Summation current sensor, splittable

for Sigma D+, Sigma D++, ComPass B series



Conductor Ø [mm]	Cable length [m]	Order no.
220-250	4.00	49-6023-020

Product matrix

Capacitive and resistive voltage signal



Function	Wega 1.2 C Page 102	Wega 2.2 C Page 106	Wega with interface cable Page 110–111	HR interface cable Page 110	Interface cable for post insulator Page 111
Capacitive voltage signal	■	■	■	■	■
Resistive voltage signal	–	–	–	–	–
Voltage indication	■	■	■	–	–
Voltage measurement	–	–	–	■	■
Connection to Sigma D series	■	■	■	■	■
Connection to ComPass B	■	■	■	■	■
Connection to ComPass B 2.0 series	■	■	■	■	■
New installation	■	■	–	–	–
Retrofit	–	–	■	■	■
Gas-/ solid insulated switchgear	■	■	■	■	–
Air-insulated switchgear	■	■	■	■	■
Features					
Maintenance-free voltage detecting system	■	■	■	–	–
Relay contacts for remote monitoring	–	■	–	–	–
Voltage indication in combination with HR interface	–	–	■	–	–
Voltage indication in combination with post insulator	–	–	■	–	–
Direct connection from HR interface to directional fault indicator	–	–	–	■	–
Direct connection from post insulator to directional fault indicator	–	–	–	–	■
Capacitive interface integrated in switchgear	■	■	■	■	■
High-precision voltage measurement	–	–	–	–	–
Installation on T connector set	–	–	–	–	–
Installation on A cone	–	–	–	–	–
Connection to Wega possible	–	–	–	–	–
Voltage calibration necessary	■	■	■	■	■



C1A1-24 Page 54	C1lx Page 54	RDP series Page 55	RDG3-24 Page 55	RDM3-24 Page 55
■	■	–	–	–
–	–	■	■	■
–	–	–	–	–
–	–	■	■	■
■	■	–	–	–
■	■	–	–	–
■	■	■	■	■
–	■	■	■	■
–	–	■	■	–
■	■	–	–	■
–	–	–	–	–
–	–	–	–	–
–	–	–	–	–
–	–	–	–	–
–	–	–	–	–
–	–	■	■	■
–	–	■	–	–
■	■	–	–	–
■	■	–	–	–

Capacitive voltage coupling

for Wega series in air-insulated switchgears

For Wega T1 vario



C1A1-24	Cable length [m]	Voltage [kV]	Order no. set
For T connector set ¹⁾ Cellpack: CHE-I 24 NKT: TI-24 Siemens: IEAS20 Nexans/Euromold: AIN20 Tyco/Raychem: IXSU-F5121	0.35	12-24	38-9100-060

1) Further cable length on request.
Wega T1 vario as well as set of connection cables see page 112



Connecting cable	Cable length ¹⁾ [m]	Order no.
Coaxial cable for connection to Wega T1 vario	4.50	49-6003-330

1) Further cable length on request.

For Wega series



C11x	Voltage [kV]	Order no.
C111-12	max. 12	3 x 48-0101-002
C112-24	max. 24	3 x 48-0101-003
C113-36	max. 36	3 x 48-0101-004

Wega 1.2 C vario as well as set of connection cables see page 111

Resistive voltage sensors

for ComPass B 2.0 series

with shielded 2 pole cable with connector, connecting terminal resistor and termination resistor

For gas-insulated switchgears



RDP1-24	Cable length [m]	Voltage [kV]	Order no. set
For T connector set ¹⁾ Nexans: (K) 400TB Cellpack: CTS Südkabel: SEHDT 13, SEHDT 23	3.5	12, 24	38-9100-013



RDP2-24	Cable length [m]	Voltage [kV]	Order no. set
For T connector set ¹⁾ NKT: CB-24, CC-24 Raychem: RSTI-58xx, RSTI-CC-58xx	3.5	12, 24	38-9100-017



RDP3-24	Cable length [m]	Voltage [kV]	Order no. set
For T connector set ¹⁾ Nexans: 430TB-630A, K430TB-630A, 300 PB-630A, K300PB-630A Südkabel: SET24, SEHDT23.1, SAT24, SEHDK23.1, SAK24, MUT23, MUT23.1, AD23.1SP	3.5	12, 24	38-9100-018



RDP4-24	Cable length [m]	Voltage [kV]	Order no. set
For T connector set ¹⁾ Cellpack: CTS630A, CTKS630A	3.5	12, 24	38-9100-019

1) Further connector sets on request.



RDG3-24	Cable length [m]	Voltage [kV]	Order no. set
Sensors with adapters for A cones	6.0	12, 24	38-9100-026



Connecting cable	Cable length ¹⁾ [m]	Order no.
For providing voltage information from ComPass B 2.0 to ComPass B 2.0	1.00	49-0509-311

1) Further cable length on request.

For air-insulated switchgears



RDM3-24	Cable length [m]	Voltage [kV]	Order no. set
For different switchgear manufacturers	6.0	12, 24	38-9100-050
Retaining plate for installation on cable brackets			49-9090-015

Accessories

For short-circuit and earth fault indicators and integrated voltage detecting systems

Wall-mounted housings

for the installation of short-circuit and earth fault indicators as well as integrated voltage detecting systems outside the switchgear



W x H x D 125 x 75 x 125 mm
Order no. 49-9001-001 bottom cable entry 49-9001-002 rear cable entry



W x H x D 125 x 175 x 125 mm
Order no. V49-9001-004-001 incl. earthing bar



W x H x D 125 x 75 x 75 mm
Order no. 49-9001-006



W x H x D 290 x 77 x 200 mm
Order no. V49-9001-007-001 incl. earthing bar

External signal lamps

for installation outside the switchgear



3 LEDs	Order no.
5 m connection cable, with battery, for permanent contact	49-0702-005
10 m connection cable, with battery, for permanent contact	49-0702-010
15 m connection cable, with battery, for permanent contact	49-0702-015



Bicolour 3 LEDs red/green	Order no.
3 m connection cable, with battery	49-0706-001



Bicolour 1 LED red/green	Order no.
2 m connection cable, with battery, without fibre optic cable (see page 57)	49-0704-001

Installation system

for Sigma D series and ComPass series



Order no.
Tablet for parameter setting during installation or monitoring, incl. cover, pencil, power supply and USB cable
49-6022-010

Temperature sensor PT100



Order no.	
Temperature range	-50 to +180 °C
Dimension	6 x 50 mm
Cable length	10 m (silicone, 2 ferrules)
Protection degree	IP65
49-9090-013	

Fibre optic cables



Order no.	
Fibre optic cable 3 m (standard length for short-circuit CTs)	49-0602-009
Fibre optic cable 4 m (standard length for earth fault CTs)	49-0602-001
Fibre optic cable 1,8 m (standard length for external signal lamp)	49-6007-206

Accessories for Opto series



Order no.
Cutting tool for fibre optic cables
49-0109-003



Order no.
Transformer with cable for top-hat rail mounting (115 V-230 V AC / 24 V-48 V AC)
49-0921-002



Order no.
Optical testing unit to excite the indicator for connection to the fibre optic cable plug
49-0109-002

Accessories for plug-in housing



Order no.	
Disassembly clip	49-9090-016
Disassembly clip for ComPass B 2.0/Bs 2.0	49-9090-017



Order no.	
Spring clip suitable for 2 mm front plate thickness (standard)	49-9090-018
Spring clip suitable for 3 mm front plate thickness	49-9090-019

ComPass BN

Load low monitoring for low voltage networks



ComPass BN



Interface box for voltage coupling

Product feature

- Current and voltage monitoring
- Load monitoring and directional load flow monitoring of P, Q, S, cos φ
- Voltage monitoring V<, V>
- Active energy to load low direction A↑ or B↓
- For low voltage networks with low-impedance and solidly earthed neutral systems
- Multilingual OLED display, additional multicolour LED
- Remote indication via RS485/Modbus interface and four freely configurable relay contacts
- User friendly, simple and intuitive operation, easy-to-read display

Your advantages

- One (ComPass)-system for low and medium voltage
- Proven technology for low voltage monitoring

The ComPass BN enables measuring and monitoring in low voltage networks. Directional short-circuit and earth fault indication is also possible.

Technical data	ComPass BN
Directional short-circuit indicator	■
Directional earth fault indicator	■
Measured values / indication	<ul style="list-style-type: none"> ■ Phase currents L1, L2, L3, V_{NE} ■ Phase-to-earth voltage V₁, V₂, V₃, V_{NE} or phase-to-phase voltage V₁₂, V₂₃, V₃₁, V_{NE} ■ Load flow direction A↑ or B↓ ■ P, Q, S and cos φ (power factor) (P_{1,2,3}, Q_{1,2,3}, S_{1,2,3}, cos φ_{1,2,3} via RS485) ■ Operating current, I₁, I₂, I₃, I_E ∅15 min, I₁, I₂, I₃ max. 24 h/7 days/365 days ■ Maximum demand indicator I max. LR (last reset) ■ Power frequency f
I>> short-circuit trip current	50–2,000 A (1 A steps)
tI>> response delay	40 ms–60 s
I _E > earth fault trip current	20–1,000 A (1 A steps) IT (isolated), TT, TN-C, TN-S, TN-C-S (solidly earthed)
tI _E > response delay	40 ms–60 s
V> overvoltage trip values	100–200 %
V< undervoltage trip values	0–100 %
Measurement accuracy phase currents	3 % (0–630 A, resolution 1 A) 5 % (630–1,500 A) 10 % (1,500–2,000 A)
Indication	<ul style="list-style-type: none"> ■ LED status display (multicolour) ■ OLED display (multilingual)
Remote signal / communication	<ul style="list-style-type: none"> ■ 4 potential-free relay contacts, freely configurable ■ RS485/Modbus interface
Remote contact	4 permanent or momentary contacts (1 s), NC or NO Contact capacity: 230 V AC / 1 A / 62.5 VA max.; 220 V DC / 1 A / 60 W max.
Reset	<ul style="list-style-type: none"> ■ By rocker switch ■ Automatic time reset: 1 min–24 h ■ Remote reset ■ Via RS485/Modbus interface ■ Voltage restoration ■ Auxiliary supply restoration
Power supply	
External auxiliary supply	24 V–230 V AC/DC (±10 %)
Internal power supply	Long-life lithium cell, active flashing time >1,000 h, >1,000 display activations, shelf life ≥20 years
Housing	Polycarbonate, IP40
Temperature range	–30 to +70 °C

Dimension drawing see on page 158, M3

Equipment set	Page	Accessories	Page
1 ComPass BN	Order no. 38-4110-001	Wall-mounted housings	56
1 interface box	Order no. 49-6021-001	Disassembly clip	57
3 single-phase current sensors	50	Spring clip	57

Trip Flag

Trip indicator relay for trip display



Trip Flag

Product features

- Suitable for connection to CT powered protection relays in gas-insulated medium voltage switchgears
- 2 drop indicators (black/red)
 - OC relay trip: Overcurrent relay trip
 - ETFS trip: External trip forced switch
- Controllable via electrical impulse output
- 2 changeover contacts per relay, self-holding
- Test/reset function for indicator and relay contacts via rotary knob

The Trip Flag is a drop indicator relay for two independent indications. It is suitable for the trip display of CT powered protection devices with electrical impulse output.

In addition to the display, output relays are activated. Each output has 2 changeover contacts. The output contacts and the display are latching and are reset manually via a rotary knob.

The Trip Flag is suitable for protection devices from Woodward (WIC1, WIB1, WIP1).

For devices of other manufacturers the electrical impulse of the outputs of the protection relays needs to be 24 V DC and $E \geq 0.01$ Ws.

Technical data	Trip Flag
Indication	2 trip displays (black/red)
Remote signal	2 changeover contacts per trip display
Remote contact	Potential-free contacts, bistable Contact capacity: 230 V AC / 1 A / 62.5 VA max.; 220 V DC / 1 A / 60 W max.
Input signal	Electrical impulse, 24 V DC ≥ 0.01 Ws
Test / Reset	Manually via rotary knob
Housing	Polycarbonate, IP40 front panel, IP20 terminals
Temperature range	-30 to +70 °C

Dimension drawing see on page 158, M4

Equipment set	Page	Accessories	Page
1 display unit Trip Flag	Order no. 49-9010-001	Wall-mounted housings	56
3 single-phase current sensors	50	Disassembly clip	57
		Spring clip	57

Product matrix

Overhead faulted circuit indicators



Function	Navigator LM Page 64	Navigator LM HV Page 64	Navigator LED + Flag Page 66	Navigator LM Radio Page 68
Short-circuit indication	■	■	■	■
Directional indication	-	-	-	-
Self-adjustment	■	■	■	■
Monitoring	-	-	-	-
Recloser mode	■	■	■	-
Nominal voltage	≤46 kV/50 Hz	≤161 kV/50 Hz	≤46 kV/50 Hz	≤46 kV/50 Hz
Withstand current	25 kA/1 s	40 kA/1 s	25 kA/1 s	25 kA/1 s
Reset				
Manual	■	■	■	■
Remote	-	-	-	-
Automatic time reset	■	■	■	■
Current restoration	■	■	■	■
Voltage restoration	■	■	■	■
Test				
Manual	■	■	■	■
Remote	-	-	-	-
Communication				
Wireless transmitter	-	-	-	■
Parameter setting				
Local	-	-	-	-
Remote	-	-	-	-
Monitoring				
Conductor temperature	-	-	-	-
Ambient temperature	-	-	-	-
Cable				
Diameter	8–29 mm	13–36 mm	8–29 mm	8–29 mm
Power supply				
Long-life lithium battery	■	■	■	■
Battery status indication	■	■	■	■

Product matrix

Smart overhead faulted circuit indicators

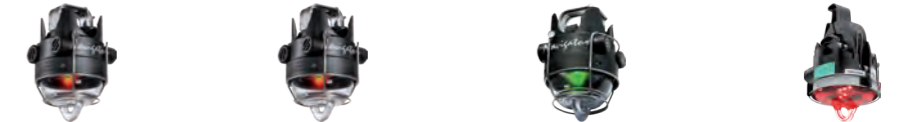

Function	Smart Navigator Page 70	Smart Navigator HV Page 70	Smart Navigator DFCI HV Page 72	Smart Navigator 2.0 Page 74
Short-circuit indication	■	■	■	■
Directional indication	-	-	■ (red/green)	■ (red/green)
Self-adjustment	■	■	■	■
Monitoring	■	■	■	■
Recloser mode	■	■	■	■
Nominal voltage	≤46 kV/50 Hz	≤161 kV/50 Hz	≤161 kV/50 Hz	7.2–46 kV/50 Hz
Withstand current	25 kA/1 s	40 kA/1 s	40 kA/1 s	25 kA/3 s
Reset				
Manual	■	■	■	■
Remote	■	■	■	■
Automatic time reset	■	■	■	■
Current restoration	■	■	■	■
Voltage restoration	■	■	■	■
Test				
Manual	■	■	■	■
Remote	■	■	■	■
Communication				
Wireless transmitter	■	■	■	■
Parameter setting				
Local	-	-	-	■
Remote	■	■	■	■
Monitoring				
Conductor temperature	-	■	■	■
Ambient temperature	■	■	■	■
Cable				
Diameter	8–29 mm	13–36 mm	13–36 mm	≤33 mm
Power supply				
Long-life lithium battery	■	■	■	■
Battery status indication	■	■	■	■

Navigator LM | Navigator LM HV

Overhead faulted circuit indicator



Navigator LM



Navigator LM HV

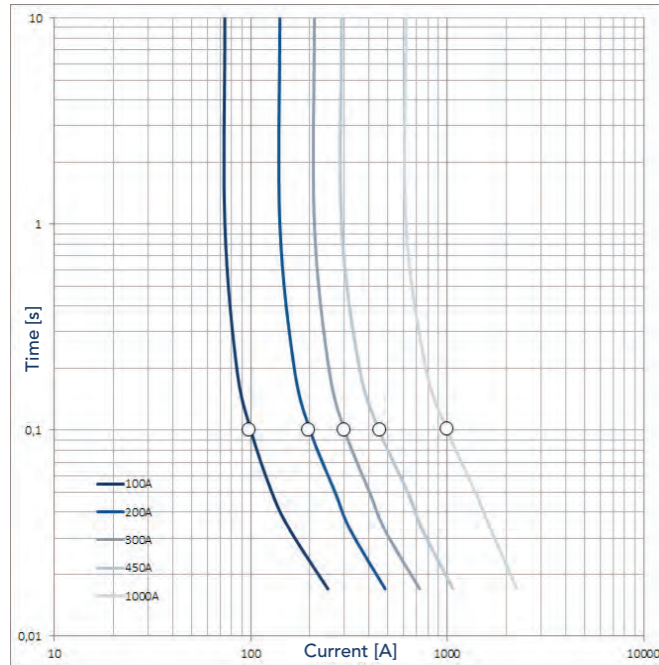

Current/time characteristic

Product features

- Fault detection
- LED indication with 360 degrees of visibility
- Double-flashing mode upon detection of a second fault
- Battery status indication
- Reset depending on type: manual, current restoration, voltage restoration
- Mounting on live overhead lines possible
- Navigator-LM HV: permissible voltage ≤ 161 kV

The Navigator fault passage indicator is an electronic device which is designed for medium voltage utility overhead lines. The indicator is provided with a self-adjusting load-dependent control of the trip current level. This function allows the indicator to continuously sample the load current on overhead lines and automatically set a corresponding trip value for fault detection as a function of the load current. The maximum load current sampled by the indicator, is kept in a memory for a period of at least 72 hours. Thus, the indicator is most favourably adapted to the network to be monitored, even if low load is currently present.

The indicator is provided with a built-in battery control. When the battery capacity decreases from a total indicating time of 500 hours to a residual time of 50 hours, the yellow LED of the display starts flashing for a period of 6 months.

The Navigator LM differentiates between two subsequent short-circuit detections. Upon the detection of a first short-circuit, the LED indicator light starts flashing at equal rates. The detection of a second short-circuit (e. g. after ARC) switches the LED to double flashing mode.

Reset options provided by the various versions.

Technical data	Navigator LM Navigator LM HV			
	Version A	Version B	Version C	Version E
Trip current	≥ 100 A/ ≥ 100 ms, load-dependent self-adjustment (see current / time characteristic)			
Accuracy	± 10 % at 20 °C			
Self-adjustment	> 30 A load current			
Trip factor	4–6 x load current (see current / time characteristic)			
Adjustment delay	60 s			
Peak load memory	72 h			
Indication (short-circuit / earth fault)	<ul style="list-style-type: none"> ■ 4 red LEDs (> 5.000 mcd resp. 7.000 mLm per piece) ■ 2 yellow LEDs (> 5.000 mcd resp. 7.000 mLm per piece) 			
Visibility	> 50 m / day, > 150 m / night, 360 degrees of visibility			
Flash rate	30 flashes per minute, total indication time > 500 h			
Reset	Version A	Version B	Version C	Version E
Manual	■	■	■	■
Automatic time reset: 4 h ± 10 % (2 or 8 h)	■	■	■	■
Current restoration load current > 3 A	■	–	Red LEDs turn off, yellow flash until manual or time reset	–
Voltage restoration line voltage ≥ 5 kV	–	–	–	■
Power supply	Lithium battery, replaceable, shelf life ≥ 20 years			
Battery check	1 yellow LED, flash rate: 6 per minute, 6 month			
Max. permissible voltage	<ul style="list-style-type: none"> ■ Navigator LM: ≤ 46 kV / 50 Hz or 60 Hz ■ Navigator LM HV: ≤ 161 kV / 50 Hz or 60 Hz 			
Withstand current	<ul style="list-style-type: none"> ■ Navigator LM: 25 kA / 1 s ■ Navigator LM HV: 40 kA / 1 s 			
Cable diameter range	<ul style="list-style-type: none"> ■ Navigator LM: 8–29 mm ■ Navigator LM HV: 13–36 mm 			
Housing	UV resistant polycarbonate / polyamide, IP68 Clamping yoke: stainless steel			
Temperature range	–30 to +70 °C (IEEE 495: –40 to +85 °C)			

Dimension drawing see on page 159, M8

Order no.						
41 –	2	0	01 –	1	1	1
Navigator series	Navigator LM	Flash rate	Conductor diameter	Reset	Trip current	Automatic time reset
41	2	1 = Single and double flash	01 = 8–29 mm (LM version) 08 = 13–36 mm (HV version)	1 = Version A 2 = Version B 3 = Version C 5 = Version E	1 = 200 A / 100 ms (50 / 60 Hz) 2 = 200 A / 200 ms (50 / 60 Hz) 3 = 100 A / 100 ms (50 / 60 Hz)	0 = 2 h 1 = 4 h (Standard) 2 = 8 h 6 = 24 h

Navigator PM without self-adjustment facility provided with fixed trip currents available ex works after consultation with the manufacturer
Product matrix on page 62

Accessories	Page
Installation tool	76
Hot stick for installation tool	76
Magnet (Test / Reset)	76
Hot stick with hook	76

Navigator LED + Flag

Overhead faulted circuit indicator



Navigator LED + Flag

Product features

- 72 hour peak load memory
- 4 hours LED automatic reset
- 1, 2 or 7 days flag automatic reset
- Self diagnostic battery circuit
- Replaceable lithium cells
- 360 degrees visibility
- Manual test and reset
- Automatic inrush restraint
- Microprocessor controlled

The Navigator LED + Flag is a faulted circuit indicator for power distribution overhead lines. The faulted circuit indication is visualised by a large red flag in combination with LEDs.

The Navigator LED + Flag has a load tracking characteristic. This means it constantly monitors the load current magnitude on the line and automatically adjusts its trip current level for a fault. The highest current sensed for at least 60 seconds will establish a trip point (~4 times load) in memory and holds this value for 72 hours. If the load current reaches or exceeds the stored load current level at any time, a new trip point is registered and the memory time of 72 hours starts again. If load current does not meet or exceed the established level for 72 hours, the Navigator LED + Flag will sense and re-establish a new lower trip point. When a fault current exceeds the trip point, the indicator activates the red flag and high intensity red LEDs will also flash. The LEDs are reset by current, time or manually whichever comes first. The red flag is reset by either time or manually, giving both an indication on permanent as well as on momentary faults. The reset times for the LED and Flag can be selected independently to combine the advantages of a blinking indicator (better visibility) at night and a mechanical flag for difficult to reach rural applications.

Technical data	Navigator LED + Flag		
	Version A	Version B	Version E
Trip current	≥50 A / ≥100 ms		
Accuracy	±10 % at 20 °C ±20 % at -30 to +70 °C		
Self-adjustment	≥20 A load current		
Trip factor	4 x load current		
Adjustment delay	60 s		
Peak load memory	72 h		
Indication (short-circuit/earth fault)	<ul style="list-style-type: none"> ■ Mechanical flag ■ 3 red LEDs for fault indication ■ 1 yellow LED for low-battery indication 		
Visibility	>50 m/day, >150 m/night, 360 degrees of visibility		
Flash rate	30 flashes per minute, total indication time >1,500 h		
Reset	Version A	Version B	Version E
Manual	■	■	■
Automatic time reset	<ul style="list-style-type: none"> ■ LED: 4 h ■ Flag: 4 h, 1, 2, 3 or 7 days 	<ul style="list-style-type: none"> ■ LED: 4 h ■ Flag: 4 h, 1, 2, 3 or 7 days 	<ul style="list-style-type: none"> ■ LED: 4 h ■ Flag: 4 h, 1, 2, 3 or 7 days
Current restoration load current >3 A	■	-	-
Voltage restoration line voltage ≥5 kV	-	-	■
Power supply	Lithium battery, replaceable, shelf life ≥20 years		
Battery check	1 yellow LED, flash rate: 6 per minute (only while flag is reset)		
Max. permissible voltage	≤46 kV/50 Hz or 60 Hz		
Withstand current	25 kA/1 s		
Cable diameter range	4–29 mm 8–29 mm		
EMC	IEC 61000-4-2 (ESD), IEC 61000-4-3 (HF)		
Housing	UV resistant glass-fibre reinforced plastic, IP68 Clamping yoke: stainless steel		
Temperature range	-30 to +70 °C (IEEE 495: -40 to +85 °C)		

Dimension drawing see on page 159, M8

Order no.						
41	-	3	2	01	-	1 2 1
Navigator series	Navigator LED + Flag	Frequency	Conductor diameter	Reset	Trip current	Flag reset
41	3	1 = 60 Hz 2 = 50 Hz	01 = 8–29 mm 04 = 4–29 mm	1 = Version A 2 = Version B 5 = Version E	0 = 100 A / 200 ms 1 = 100 A / 100 ms 2 = 200 A / 200 ms (60 Hz) 2 = 200 A / 100 ms (50 Hz) 6 = 50 A / 200 ms (60 Hz) 6 = 50 A / 100 ms (50 Hz)	1 = 4 h 5 = 3 days 6 = 1 day 7 = 7 days 8 = 2 days

Product matrix on page 62

Accessories	Page
Installation tool	76
Hot stick for installation tool	76
Magnet (Test / Reset)	76
Hot stick with hook	76

Navigator LM Radio

Overhead faulted circuit indicator



Navigator LM Radio

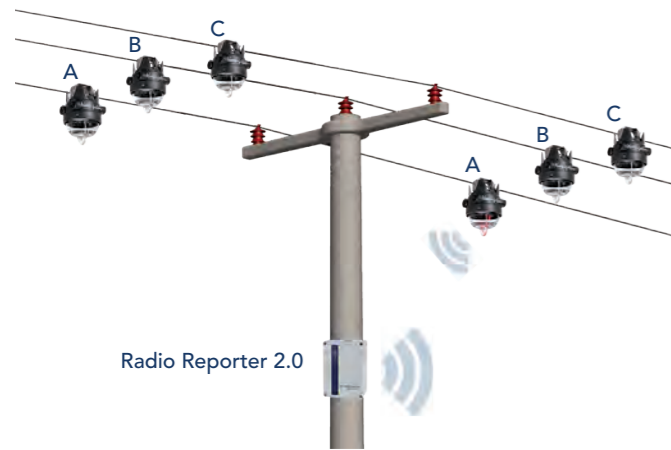

Phase-selective message

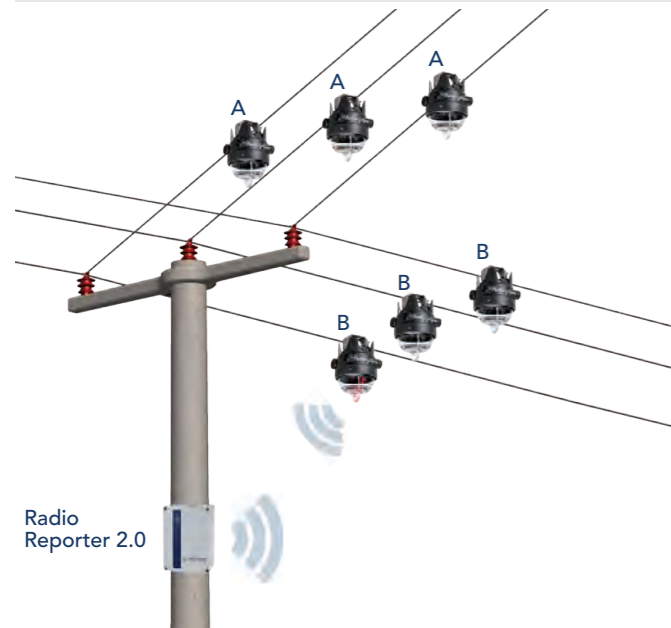

Group-selective message

Product features

- Load-dependent self-adjusting overhead line fault detection and indication
- Coded radio transmission to Radio Reporter 2.0

The Navigator LM Radio works always in combination with a Radio Reporter 2.0 which is mounted on the overhead line pole. Once a short-circuit has been detected, the Navigator starts flashing and transmits a radio signal to the Radio Reporter 2.0.

Technical data	Navigator LM Radio		
	Version A	Version B	Version E
Trip current	≥50 A/≥100 ms, load-dependent self-adjustment (without load tracking)		
Accuracy	±10 % at 20 °C ±20 % at -20 to +70 °C		
Self-adjustment	≥20 A load current		
Trip factor	4 x load current		
Adjustment delay	60 s		
Peak load memory	72 h		
Indication (short-circuit)	1 red LED		
Visibility	>50 m/day, >150 m/night, 360 degrees of visibility		
Flash rate	30 flashes per minute, total indication time >150 faults		
Reset	Version A	Version B	Version E
Manual	■	■	■
Automatic time reset 4 h ±10 %	■	■	■
Current restoration load current >3 A	■	-	-
Voltage restoration line voltage ≥5 kV	-	-	■
Power supply	Lithium battery, replaceable, shelf life ≥20 years		
Battery check	1 yellow LED, flash rate: 6 per minute, total indication time >700 h		
Max. permissible voltage	≤46 kV/50 Hz or 60 Hz		
Withstand current	25 kA/1 s		
Communication			
Radio transmission	Integrated antenna		
Frequency	869.850 MHz ±25 kHz		
Capacity	1 mW		
Modulation	FM		
Transmission	Periodically every 1.5 s for 100 ms		
Transmission range	>30 m		
Coding	A, B, C and D (each with excitation and battery control)		
Cable diameter range	8–29 mm		
EMC	IEC 61000-4-2 (ESD), IEC 61000-4-3 (HF)		
Housing	UV resistant glass-fibre reinforced plastic, IP68 Clamping yoke: stainless steel		
Temperature range	-30 to +70 °C (IEEE 495: -40 to +85 °C)		

Dimension drawing see on page 159, M8

Order no.						
41	-	8	1	01	-	1 1 1
Navigator series	Navigator LM Radio	Reset	Frequency/ response delay	Coding	Trip current	
41	8	1 = Version A 2 = Version B 5 = Version E	0 = 60 Hz/200 ms 1 = 50 Hz/100 ms 2 = 50 Hz/200 ms 3 = 60 Hz/100 ms	1 = Transmitter Code A 2 = Transmitter Code B 3 = Transmitter Code C 4 = Transmitter Code D	0 = 100 A 1 = 200 A 2 = 50 A	

Product matrix on page 62

Accessories	Page
Radio Reporter 2.0	94
Installation tool	76
Hot stick for installation tool	76
Magnet (Test/Reset)	76
Hot stick with hook	76

Smart Navigator | Smart Navigator HV

Smart overhead faulted circuit indicator



Smart Navigator | Smart Navigator HV

Product features

Event based data reports:

- Fault detection; momentary versus permanent
- Fault current magnitude
- Fault duration
- Last good known load current
- Time stamp

Continuous data reports:

- Battery status
- Average load current
- Peak and min. load current
- Ambient temperature

The Smart Navigator overhead faulted circuit indicator (FCI) is designed for smart grid automation applications. It can be installed on overhead transmission and distribution power lines up to 46 kV (161 kV HV-versions) and provides event based fault status in addition to continuous circuit data.

The Smart Navigator can be integrated into an existing SCADA or smart grid system and can operate in various communication environments. A pole mounted concentrator receives and manages all Navigator data as an access point into a communication environment.

The Smart Navigator detects fault events and provides digital and analogue fault data information for intelligent switching and restoration decisions.

The load levelling and load memory features enable the unit to automatically set fault trip current rating in relation to peak load current. Once the unit detects fault current above its trip current rating the FCI sends a signal to the pole mounted concentrator and begins to flash a bright red blinking LED.

Smart Navigator HV

The Smart Navigator HV features all the function provided by the Smart Navigator. In addition to event based fault identification, the Smart Navigator HV also communicates fault data, load current and status data. An integrated conductor temperature sensor is an important diagnostic tool to evaluate line sag and potential hotspots.

Technical data	Smart Navigator Smart Navigator HV		
	Version A	Version B	Version E
Trip current	50–1,200 A		
Accuracy	±10 % at 20 °C		
Self-adjustment	≥20 A load current		
Trip factor	4 x load current		
Adjustment delay	60 s		
Peak load memory	72 h		
Indication (short-circuit/earth fault)	Bright red LED		
Visibility	>50 m/day, >150 m/night, 360 degrees of visibility		
Flash rate	30 flashes per minute, total indication time >500 h		
Reset	Version A	Version B	Version E
Manual	■	■	■
Automatic time reset: 4 h ±10 %	■	■	■
Current restoration load current >3 A	■	–	–
Voltage restoration line voltage ≥5 kV	–	–	■
Power supply	Lithium battery, replaceable, shelf life ≥20 years		
Battery check	1 yellow LED, flash rate: 6 per minute, 6 months		
Max. permissible voltage	Smart Navigator: ≤46 kV L-L Smart Navigator HV: ≤161 kV L-L		
Withstand current	Smart Navigator: 25 kA/1 s Smart Navigator HV: 40 kA/1 s		
Conductor temperature measurement range	-40 to +130 °C		
Conductor temperature measurement accuracy	±5 °C		
Communication			
Frequency	2.4 GHz		
Power	1 mW		
Modulation	MSK		
Reporting cycle	15 minutes		
Range	>30 m line-of-sight		
Cable diameter range	Smart Navigator: 8–29 mm Smart Navigator HV: 13–36 mm		
Housing	UV resistant glass-fibre reinforced plastic, IP68 Clamping yoke: stainless steel		
Temperature range	-40 to +85 °C (IEEE 495: -40 to +85 °C)		

Dimension drawing see on page 159, M8

Order no.							
43	–	4	0	2	6	–	1 0 0
Navigator series	Smart Navigator	Radio module	Trip current	Conductor diameter	Reset		Automatic time reset
43	2=60 Hz/200 ms 3=50 Hz/100 ms 4=50 Hz/100 ms	0=2,4 GHz 1=2,4 GHz + conductor temperature sensor (HV version)	0=50 A 1=100 A 2=200 A	6= 8–29 mm 7= 4–29 mm 8= 13–36 mm (HV version)	1=Version A 2=Version B 5=Version E	0	0=4 h 2=8 h

Product matrix on page 63

Accessories	Page
Smart Reporter	96
Installation tool	76
Hot stick for installation tool	76
Magnet (Test / Reset)	76
Hot stick with hook	76

Smart Navigator DFCI HV

Directional smart overhead faulted circuit indicator



Smart Navigator DFCI HV

Product features

Event based data reports:

- Fault detection including fault direction (red/green)
- Momentary versus permanent fault
- Fault current magnitude
- Fault duration
- Last good known load current
- Loss of current

Continuous data reports:

- Actual current
- 15 min average load current
- 15 min peak and min load current
- Device temperature
- Conductor temperature
- Routine call and health check
- Battery status

The Smart Navigator HV DFCI overhead faulted circuit indicator is designed for smart grid automation applications. It can be installed on overhead transmission and distribution power lines up to 161 kV and provides event based fault status in addition to continuous circuit data.

In addition to the standard Smart Navigator HV, the Smart Navigator HV DFCI also provides information about the fault direction.

It can be integrated into an existing SCADA or smart grid system and can operate in various communication environments. A pole mounted concentrator receives and manages all Navigator data as an access point into a communication environment.

The Smart Navigator HV DFCI detects fault events and provides digital and analogue fault data information for intelligent switching and restoration decisions. A conductor temperature sensor is available as an important diagnostic tool to evaluate line sag and potential hotspots.

The load leveling and load memory features enable the unit to automatically set fault trip current rating in relation to peak load current. Once the unit detects fault current above its trip current rating the FCI sends a signal to the pole mounted concentrator and begins to flash bright red or green blinking LEDs. In addition to event based fault identification, the Smart Navigator HV DFCI also communicates load current and status data.

Technical data	Smart Navigator DFCI HV		
	Version A	Version B	Version E
Trip current	50–1,200 A		
Accuracy	±10 % at 20 °C		
Self-adjustment	≥20 A load current		
Trip factor	4 x load current		
Adjustment delay	60 s		
Peak load memory	72 h		
Indication (short-circuit/earth fault)	Bright red and green LED		
Visibility	>50 m/day, >150 m/night, 360 degrees of visibility		
Flash rate	30 flashes per minute, total indication time >500 h		
Reset	Version A	Version B	Version E
Manual	■	■	■
Automatic time reset: 4 h ±10 %	■	■	■
Current restoration load current >3 A	■	–	–
Voltage restoration line voltage ≥5 kV	–	–	■
Power supply	Lithium battery, replaceable, shelf life ≥20 years		
Battery check	1 yellow LED, flash rate: 6 per minute, 6 month		
Max. permissible voltage	≤161 kV L-L		
Withstand current	40 kA/1 s		
Conductor temperature measurement range	–40 to +130 °C		
Conductor temperature measurement accuracy	±5 °C		
Communication			
Frequency	2.4 GHz		
Power	1 mW		
Modulation	MSK		
Reporting cycle	15 minutes		
Range	>30 m line-of-sight		
Cable diameter range	13–36 mm		
Housing	UV resistant glass-fibre reinforced plastic, IP68 Clamping yoke: stainless steel		
Temperature range	–40 to +85 °C (IEEE 495: –40 to +85 °C)		

Dimension drawing see on page 159, M8

Order no.							
43	–	4	5	2	6	–	1 0 0
Navigator series	Smart Navigator	Radio module	Trip current	Conductor diameter	Reset		Automatic time reset
43	2=60 Hz/200 ms 3=50 Hz/100 ms 4=50 Hz/100 ms	5=2,4 GHz + conductor temperature sensor	0=50 A 1=100 A 2=200 A	8=13–36 mm 9= 4–29 mm	1=Version A 2=Version B 5=Version E	0	0=4 h 2=8 h

Product matrix on page 63

Accessories	Page
Smart Reporter	96
Installation tool	76
Hot stick for installation tool	76
Magnet (Test/Reset)	76
Hot stick with hook	76

Smart Navigator 2.0

Self-powered overhead line sensor | smart faulted circuit indicator



Smart Navigator 2.0 Satellite



Smart Navigator 2.0 Master

Product features

- Quick fault detection – locally and in the control room at the same time
- Remote monitoring of measured values – high-precision current measurements, load flow direction and conductor temperature
- Embedded WAN communication – no box on the pole required – quick and easy installation saves costs
- Remote configuration and updates via iHost or locally via USB transmitter
- High availability of the medium voltage overhead lines – reduces outage times

The Smart Navigator 2.0 continuously monitors the overhead line and provides measured values and fault information to the control room. This enables engineers (or automated algorithms) to initiate immediate switching and circuit restoration decisions.

The indicator is a self-powered sensor, which harvests its power supply from the overhead line. Power is stored in a rechargeable lithium cell for periods with low or no load current.

Each unit is simply and securely clipped onto a phase conductor of the overhead line. A set of three units, at each monitored location, consists of one master and two satellite units. The master communicates via cellular networks directly to SCADA without the need for a pole-mounted box.

Technical data	Smart Navigator 2.0
Trip current	7–1,200 A (load tracking) or fixed trip up to 2,000 A
Current measurement accuracy	±2 A (0–10 A) 3 % (10–600 A) 5 % (600–10,000 A)
Self-adjustment	≥2 A load current
Trip factor	4 x load current
Peak load memory	72 h
di/dt trip value	≥5 A, adjustable
Indication	Ultra-bright high power LEDs
Visibility	>50 m/day, >150 m/night, 360 degrees of visibility
Flash rate	30 flashes per minute
Reset	
Manual	<ul style="list-style-type: none"> ▪ By magnet ▪ Local via USB transmitter
Remote	Via iHost
Automatic time reset	4 h ±10 %
Current restoration	>3 A load current
Voltage restoration	>5 kV line voltage
Power supply	<ul style="list-style-type: none"> ▪ Power inductively from line current (>5 A) ▪ Internal rechargeable back-up-battery ▪ Optional: primary battery
Power distribution line voltage	<ul style="list-style-type: none"> ▪ Standard: 7.2–46 kV (L–L) ▪ HV version: 7.2–161 kV (L–L)
Withstand current	600 A continuous, 25 kA/3 s
Event reporting	<ul style="list-style-type: none"> ▪ Fault detection ▪ Loss of current or voltage ▪ Fault current magnitude and duration
Remote monitoring	<ul style="list-style-type: none"> ▪ Load current monitoring (max/min/average) ▪ Voltage presence or absence (E-field based detection)
Communication	WAN: 4G cellular modem Local: 868/915 MHz short range wireless radio (range: 100 m)
Cellular (WAN)	<ul style="list-style-type: none"> ▪ 1 SIM card (only for master) ▪ 4G and others ▪ TLS secured data transmission
SCADA	<ul style="list-style-type: none"> ▪ DNP3 from Master to iHost ▪ iHost supports DNP3, 104, 101 and other protocols ▪ iHost acts as data concentrator, fleet and connection manager
Configuration and firmware	<ul style="list-style-type: none"> ▪ Remotely (re)configurable settings over the air ▪ Supports firmware updates over the air ▪ Remote interface from SCADA/iHost or with USB transmitter on site
Cable diameter range	Up to 33 mm
Housing	UV resistant polycarbonate, IP68
Temperature range	–40 to +85 °C

Dimension drawing see on page 159, M9

Order no.					
44	–	10	0	0	– 1 00
Navigator series	Hardware	Function	Local radio	Cellular	Variants
44	11=Rechargeable battery 12=Primary battery 20=HV version	1=I>>, 50 Hz 2=I>>, I<>, 50 Hz 3=I>>, I<>, direction, 50 Hz 4=I>>, 60 Hz 5=I>>, I<>, direction, 60 Hz	0=868 MHz 2=915 MHz	0=Without modem (Satellite) 1=4G Modem EU (Master) 2=4G Modem APAC (Master)	00=Standard settings

Product matrix on page 63

Accessories	Page
Connection to iHost	77
USB transmitter	76
Commissioning tablet	76
Magnet (Test/Reset)	76
Hot stick with hook	76

Accessories

For overhead line faulted circuit indicators



Magnet (Test/Reset)	Order no. 49-6001-002
---------------------	--------------------------



Installation tool for overhead faulted circuit indicator installations and removals (except Smart Navigator 2.0)	Order no. 49-6006-004
--	--------------------------



Telescopic stick with universal end fitting (length: approx. 6.43 m) Rated voltage: 123 kV (only when fully extended)	Order no. 65-0305-001
--	--------------------------



USB transmitter for Smart Navigator 2.0	Order no. 28-5000-001
---	--------------------------



Commissioning tablet for Smart Navigator 2.0	Order no. 49-6022-030
--	--------------------------

Hot stick with hook

for overhead faulted circuit indicator installations and removals in dry weather conditions

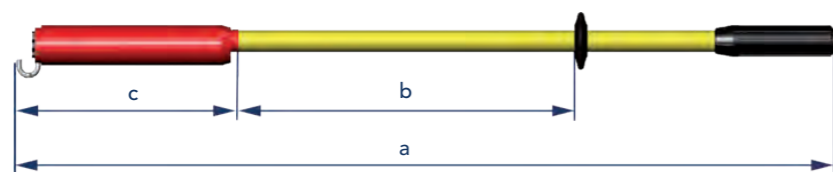

Hot stick with hook

Nominal voltage max. [kV]	Dimensions [mm]			Order no.
	a	b	c	
20	1,200	500	310	65-0301-001
30	2,000	900	310	65-0301-002
30	3,000	900	1,310	65-0301-003
46	2,000	900	310	65-0301-004

Remote monitoring

General information



Energy supply grids are becoming more and more complex. One major reason for this is the growing number of decentralised feeding lines originating from renewable energy sources. This trend is expected to continue, as evidenced by the discussions about intelligent substations and smart grids. Additional decentralised energy generation systems, such as fuel cells or battery stations, could be integrated into the grids in future.

Challenges faced by network operators:

- Increasing network complexity
- Ensuring consistently high availability of energy supply
- Increasing competitive pressure

In addition, the bonus/penalty regulations arising from ASIDI metrics create a high incentive for the reduction of power outage durations.

The Horstmann solution:

Remote monitoring solutions with direct reports of short-circuit and earth fault indicators installed in the network to a control room or directly to field service staff via their mobile devices.

- Specific coordination of service teams
- Minimisation of power outage periods
- Continuous overview of the most important network parameters

Horstmann's product range includes different remote monitoring solutions (radio-based) for underground cable and overhead lines in a medium voltage network. Leading this innovative approach is the iHost system (see page 81) which collects data from short-circuit and earth fault indicators in the field, evaluates it and provides utilities with information about network performance and irregularities.

Product matrix

Remote monitoring



Function	Reporter 3.0 Page 86	Reporter 4.0 Page 88	ComPass AX12 Page 90
SCADA			
iHost	■	■	■
Existing SCADA	-	-	-
Data source			
Underground short-circuit and earth fault indicator	■	■	■ (integrated)
Overhead faulted circuit indicator	-	-	-
Information			
Short-circuit and earth fault indication	■	■	■
Monitoring	-	■	■ (I)
Bidirectional cellular data connection	■	■	■
Routine call	■	■	■
Automatic date and time synchronisation	■	■	■
Transmission of signal field strengths	■	■	■
Temperature sensor	■	■	■
Freely programmable SMS and e-mail texts	■	■	■
Data communication			
Inputs			
Analogue	■	■	■
Digital	■	■	■
Modbus	-	■	■
Outputs			
Interface/protocol	-	Modbus	Relay contacts
Power supply			
External auxiliary supply	-	■	■
Back-up battery (rechargeable)	-	■	■
Long-life lithium cell	■	-	■
Housing			
Cable entries	■	■	■
Installation	Wall mounted	Wall mounted	Wall mounted



ComPass BX12 Page 92	Radio Reporter 2.0 Page 94	Smart Reporter Page 96
■	■	-
-	-	■
Data source		
■ (integrated)	-	-
-	■	■
Information		
■	-	■
■ (I+U)	-	■
■	■	-
■	■	-
■	■	-
■	■	-
■	■	-
Data communication		
Inputs		
■	-	■
■	-	■
■	-	■
Outputs		
Relay contacts	-	-
-	-	-
Power supply		
■	-	■
■	-	■
■	■	-
Housing		
■	-	■
Wall mounted	Pole mounted	Pole mounted



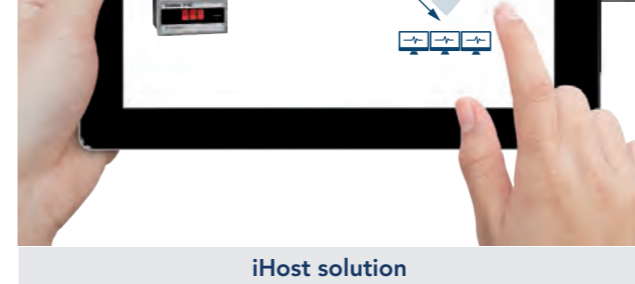

Advantages at a glance:

- Current information about network performance
- Continuous network supervision prevents power outages
- Alerts in the case of faults or irregularities
- Analysis tools for increasing network visibility

Product features:

- Data concentrator for short-circuit and earth fault indicators
 - Bundles and processes all data received from remote field devices
 - Provides data access at any time in various ways and devices
- Central management of all field devices – with one click
 - Grid monitoring: system overview, data analysis, health checks
 - Configuration and firmware updates from SCADA
- Data on demand
 - Customised visualisation of data and alarms
 - Individual notifications, generated automatically
- Embedded database
 - Grid data available from day one of installation
 - Flexible data provision for asset management, planning, engineers and further user

Horstmann products are in step with the times:

As grids become increasingly complex and heterogeneous, greater demands are placed on the availability of electricity networks. The increasing use of renewable energy sources and the desire for decentralisation play important roles in this development.

The Horstmann solution:

Information based network monitoring – the iHost system reduces power outage times thanks to quicker availability of information.

The iHost system collects data from devices such as from the short-circuit and earth fault indicators in the field (e.g. of the Compass series – see page 44), evaluates the data in a data concentrator and shares it with the control room systems and/or mobile terminals. Fault information and exceeded limits can also be send by e-mail or SMS.



iHost Cloud



iHost Compact

iHost Cloud

For smaller scale projects or pilot schemes iHost Cloud is the best choice. Quick and easy implementation works without software installation. Handling is very user-friendly – all you need is a web-enabled device, your username and password. Customised notifications in case of a fault or alarms are possible via SMS and e-mail.

iHost Compact

If you want to see the data in your SCADA, iHost Compact is the right choice. With this solution iHost becomes part of your SCADA infrastructure. Installed on a physical or a virtual server iHost is a gateway that processes all data and forwards them directly to your SCADA. With iHost Compact you manage all remote devices installed in the power network.

Feature	iHost Cloud	iHost Compact		
		Software	Software/hardware	Software/hardware/101
Hardware/Server arrangement	<ul style="list-style-type: none"> High availability cluster Software as a service 	Single server, customer supplied	Single server, Horstmann supplied	Single server, Horstmann supplied with serial interface
Operating system (OS)	Cloud service/ data centre	Virtualisation file	Microsoft Windows Server OS	Microsoft Windows Server OS
Visualisation	Web browser	VMware Hyper-V		
SIM cards for smart FCI/RTU	Included in service	SCADA		
iHost licence type	Software included	Customer supplied SIM with private APN		
RTU count	1–1,000	One-time license fees		
Limits of users/user roles	50/3	50/250/500		
Maps	Yes	2/2		
Notifications	Yes (e-mail/SMS)	No		
Historian	Yes	No		
Data access API	No	No		
SCADA protocols	n/a	IEC60870-5-101 ¹⁾ IEC60870-5-104 DNP3 (serial) ¹⁾ DNP3 (IP)	IEC60870-5-104 DNP3 (IP)	IEC60870-5-101 IEC60870-5-104 DNP3 (serial) DNP3 (IP)
Simultaneous SCADA channels	n/a	2		

1) Customers server hardware must contain serial interface.

iHost Cloud	Accessories	Page
1 licence	Smart Navigator 2.0	74
Cloud 1–1000	Reporter 3.0	86
1 SIM card	Reporter 4.0	88
Cloud – 1 SIM-S*	ComPass AX12	90
Cloud – 1 SIM-M**	ComPass BX12	92
	Radio Reporter 2.0	94
iHost Compact Software		
1 licence		
Compact 50 (SW)	Order no. 79-1110-000	
Compact 250 (SW)	Order no. 79-1120-000	
Compact 500 (SW)	Order no. 79-1130-000	
1 software installation package (remote VPN access)	Order no. 79-1160-000	
1 technical support for 12 months	Order no. 79-1150-000	
iHost Compact Software/hardware		
1 licence		
Compact 50 (SW/HW)	Order no. 79-1110-100	
Compact 250 (SW/HW)	Order no. 79-1120-100	
Compact 500 (SW/HW)	Order no. 79-1130-100	
1 software installation package (remote VPN access)	Order no. 79-1160-000	
1 technical support for 12 months	Order no. 79-1150-000	
iHost Compact Software/hardware/101		
1 licence		
Compact 50 (SW/HW/101)	Order no. 79-1110-101	
Compact 250 (SW/HW/101)	Order no. 79-1120-101	
Compact 500 (SW/HW/101)	Order no. 79-1130-101	
1 software installation package (remote VPN access)	Order no. 79-1160-000	
1 technical support for 12 months	Order no. 79-1150-000	

*SIM-S includes a maximum of 10 MB data volume per SIM card
**SIM-M includes >10 MB data volume per SIM card



iHost Solo



iHost Pro

With iHost Solo and iHost Pro all measured values as well as fault information are transferred directly to your SCADA and are available on mobile devices at the same time. All data is stored in iHost. Installed in your premises these solutions provide you multiple options regarding the use, analysis and visualisation of data.

iHost Solo

iHost Solo is designed for medium sized distribution networks whereas iHost Pro can handle the variety of remote devices, even of large distribution utilities.

iHost Pro

Complete with high availability resilience the system supports all departments of your company. The system can be tailored for user groups depending on their requirements.

Feature	iHost Solo Software	Software/hardware	Software/hardware/101	iHost Pro
Hardware/Server arrangement	Single server, customer supplied	Single server, Horstmann supplied	Single server, Horstmann supplied with serial interface	Multiple server, customer supplied
	Virtualisation file			Virtualisation file
Operating system (OS)	VMware Hyper-V	Microsoft Windows Server OS	Microsoft Windows Server OS	VMware Hyper-V
Visualisation	SCADA and web browser			
SIM cards for smart FCI/RTU	Customer supplied SIM with private APN			
iHost licence type	One-time license fees			Annual license fees
RTU count	100/500/1,000			2,000/3,500/5,000
Limits of users/user roles	50/10			Unlimited/50
Maps	Yes (option)			
Notifications	Yes (e-mail/SMS)			
Historian	Yes			
Data access API	Yes			
SCADA protocols	IEC60870-5-101 ¹⁾ IEC60870-5-104 DNP3 (serial) ¹⁾ DNP3 (IP)	IEC60870-5-104 DNP3 (IP)	IEC60870-5-101 IEC60870-5-104 DNP3 (serial) DNP3 (IP)	IEC60870-5-101 ¹⁾ IEC60870-5-104 DNP3 (serial) ¹⁾ DNP3 (IP)
Simultaneous SCADA channels	2			10

1) Customers server hardware must contain serial interface.

iHost Solo Software		Accessories	Page
1 licence		Smart Navigator 2.0	74
Solo 100 (SW)	Order no. 79-1210-000	Reporter 3.0	86
Solo 500 (SW)	Order no. 79-1220-000	Reporter 4.0	88
Solo 1000 (SW)	Order no. 79-1230-000	ComPass AX12	90
1 software installation package (remote VPN access)	Order no. 79-1260-000	ComPass BX12	92
1 technical support for 12 months	Order no. 79-1250-000	Radio Reporter 2.0	94
iHost Solo Software/hardware			
1 licence			
Solo 100 (SW/HW)	Order no. 79-1210-100		
Solo 500 (SW/HW)	Order no. 79-1220-100		
Solo 1000 (SW/HW)	Order no. 79-1230-100		
1 software installation package (remote VPN access)	Order no. 79-1260-000		
1 technical support for 12 months	Order no. 79-1250-000		
iHost Solo Software/hardware/101			
1 licence			
Solo 100 (SW/HW/101)	Order no. 79-1210-101		
Solo 500 (SW/HW/101)	Order no. 79-1220-101		
Solo 1000 (SW/HW/101)	Order no. 79-1230-101		
1 software installation package (remote VPN access)	Order no. 79-1260-000		
1 technical support for 12 months	Order no. 79-1250-000		
iHost Pro Software			
1 licence			
Pro 2000	Order no. 79-1310-000		
Pro 3500	Order no. 79-1320-000		
Pro 5000	Order no. 79-1330-000		
1 software installation package (remote VPN access)	Order no. 79-1360-000		
1 technical support for 12 months	Order no. 79-1350-000		

Reporter 3.0

Remote monitoring to iHost



Reporter 3.0

Product features

- Detection and forwarding of digital states as generated e.g. by short-circuit or earth fault indicators, door contacts etc.
- Bidirectional data transfer to iHost
- Internal battery supply/ no auxiliary supply necessary

The Reporter 3.0 is used for the remote signalling of short-circuits, earth faults and additional status reports (door contact, temperature sensor etc.) from a medium-voltage network that are reported by short-circuit and earth fault indicators. The received reports are transferred to iHost through a bidirectional data connection. The Reporter 3.0 is housed in robust, weatherproof housing for wall mounting and can be configured using Windows-based PC software and iHost.

Reported short-circuits and earth faults are securely sent to SCADA via the iHost system and can be retrieved by any web-enabled device at any time. Notifications can also be received by e-mail and/or SMS.



Technical data	Reporter 3.0
Special features	<ul style="list-style-type: none"> ▪ Routine call ▪ Automatic date and time synchronisation ▪ Transmission of signal field strength ▪ Temperature sensor ▪ Fault and status notification via SMS and/or e-mail
Inputs	<ul style="list-style-type: none"> ▪ 16 digital inputs for potential-free relay contacts ▪ 2 analogue inputs (4–20 mA)
Communication	Bidirectional data connection to iHost
Indication (inside)	Control LEDs for data reception/connection
Power supply	Replaceable long-life lithium cell 7–10 years, min. 1,000 calls
Housing	Glass fibre reinforced polycarbonate, IP66
Installation	Wall mounting
Temperature range	–30 to +70 °C

Dimension drawing see on page 159, M10

Equipment set	Page	Accessories	Page
1 Reporter 3.0	Order no. 28-7330-022	Fault indicators with relay contacts	20–42
1 iHost solution			
iHost Cloud	82		
iHost Compact	82		
iHost Solo	84		
iHost Pro	84		

Product matrix on page 78

Reporter 4.0

Remote monitoring to iHost



Reporter 4.0

Product features

- Detection and forwarding of digital states as generated e.g. by short-circuit or earth fault indicators, door contacts etc.
- Transfer via bidirectional data connection to iHost
- Auxiliary supply necessary

The Reporter 4.0 is used for the remote signalling of short-circuits, earth faults and additional status reports from a medium-voltage network. The information is transferred by ComPass B or ComPass B 2.0 in particular. Voltage, current, load flow direction, power factor, power, energy and frequency are also measured and monitored. The received reports are transferred to iHost through a bidirectional data connection. The Reporter 4.0 is housed in robust, weatherproof housing for wall mounting and can be configured using Windows-based PC software and iHost.

Reported short-circuits and earth faults are securely sent to SCADA via the iHost system and can be retrieved by any web-enabled device at any time. Notifications can also be received by e-mail and/or SMS.

Technical data	Reporter 4.0
Special features	<ul style="list-style-type: none"> ▪ Routine call ▪ Automatic date and time synchronisation ▪ Transmission of signal field strength ▪ Temperature sensor ▪ Fault and status notification via SMS and/or e-mail
Inputs	<ul style="list-style-type: none"> ▪ 16 digital inputs (hardware) ▪ 8 analogue inputs (4–20 mA) (hardware) ▪ 63 Modbus (digital) – 47 if hardware inputs are used ▪ 68 Modbus (analogue) – 60 if hardware inputs are used
Interfaces	Modbus
Communication	Bidirectional data connection to iHost
Indication	Control LEDs for data reception/connection/fault indicators
Power supply	
Internal power supply	Back-up battery, max. 24 h
External auxiliary supply	100–240 V AC (50–60 Hz)
Housing	Glass fibre reinforced polyester, IP66
Installation	Wall mounting
Temperature range	–20 to +65 °C

Dimension drawing see on page 159, M11

Equipment set	Page	Accessories	Page
1 remote monitoring box		ComPass B	44
Reporter 4.0 for ComPass B	Order no. 28-7502-053	ComPass B 2.0/Bs 2.0	46
Reporter 4.0 for ComPass B 2.0/Bs 2.0	Order no. 28-7502-055		
1 iHost solution			
iHost Cloud	82		
iHost Compact	82		
iHost Solo	84		
iHost Pro	84		

Product matrix on page 78



ComPass AX12

Remote monitoring to iHost



ComPass AX12

Product features

- Integrated short-circuit and earth fault indicator
- Acquisition and transmission of faults and data
- Continuous phase-selective current monitoring
- Retrofittable, easy and quick installation
- Bidirectional data transfer to iHost

The ComPass AX12 is a compact solution, combining an earth fault and short-circuit indicator with an integrated RTU. Alarms and warnings are reported immediately with date/time stamp to SCADA. This feature helps utilities to improve their efficiency by reducing outage times in the distribution system in order to increase system reliability.

In addition, this remote underground monitoring solution provides important grid parameters from the medium voltage network, e. g. phase selective load flow, temperature and other data transmitted to the control room. This will have a major impact in the future for event history allocation, interactive trend graphs and GIS map integration.

Utilities are able to analyse and evaluate a variety of information, leading to better understanding and management of complex underground medium voltage networks. Furthermore, the utilities will be able to be more pro-active in preventing incidents. Measured values, network events and additional information are sent to the secured server and may be accessed from any web-enabled device – e-mail and/or SMS notifications are also available.

Horstmann's intuitive and user friendly iHost application provides network overview anytime – not only in case of outages.



Technical data	ComPass AX12
I>> short-circuit trip current	10–2,000 A (1 A steps)
tI>> response delay	40 ms–60 s (10 ms steps)
IΕ> earth fault trip current	20–1,000 A
tIΕ> response delay	40 ms–60 s
Measured values / indication	<ul style="list-style-type: none"> ▪ Phase currents I₁, I₂, I₃, I_E with phase angle ▪ Operating current, I₁, I₂, I₃, I_E ∅15 min, I₁, I₂, I₃ max. 24 h/7 days/365 days ▪ Maximum demand indicator I max. LR (last reset) I₁, I₂, I₃ ▪ Frequency f ▪ Temperature T
Measurement accuracy phase currents	3 % (0–630 A, resolution 1 A) 5 % (630–1,500 A) 10 % (1,500–2,000 A)
Indication	<ul style="list-style-type: none"> ▪ LED status display (multicolour) ▪ OLED display (multicolour)
Remote signal / communication	<ul style="list-style-type: none"> ▪ 4 potential-free relay contacts, freely configurable ▪ RS485 / Modbus interface
Remote contact	4 potential-free permanent or momentary contacts (1 s), NC or NO Contact capacity: 230 V AC / 1 A / 62.5 VA max.; 220 V DC / 1 A / 60 W max.
Reset	<ul style="list-style-type: none"> ▪ By rocker switch ▪ Automatic time reset: 1 min–24 h ▪ Remote reset ▪ Via RS485 / Modbus interface ▪ Current restoration
Event history	<ul style="list-style-type: none"> ▪ Last 20 events locally ▪ Unlimited in iHost
Special features	<ul style="list-style-type: none"> ▪ Routine call ▪ Automatic date and time synchronisation ▪ Transmission of signal field strength ▪ Temperature sensor
Inputs	<ul style="list-style-type: none"> ▪ 16 digital inputs (hardware) ▪ 8 analogue inputs (4–20 mA) (hardware) ▪ 63 Modbus (digital) – 47 if hardware inputs are used ▪ 68 Modbus (analogue) – 60 if hardware inputs are used
Interfaces	Modbus
Communication	Bidirectional data connection to iHost
Power supply	
Internal power supply	Back-up battery, max. 48 h
External auxiliary supply	85–264 V (50–60 Hz)
Housing	Glass fibre reinforced polyester, IP66
Installation	Wall mounting
Temperature range	–20 to +65 °C

Dimension drawing see on page 159, M12

Equipment set	Page
1 remote monitoring box	
ComPass AX12 with 1 ComPass A	Order no. 28-7502-021
ComPass AX12 with 2 ComPass A	Order no. 28-7502-020
3 single-phase current sensors per ComPass A	50
1 iHost solution	
iHost Cloud	82
iHost Compact	82
iHost Solo	84
iHost Pro	84

Product matrix on page 78

ComPass BX12

Remote monitoring to iHost



ComPass BX12

Product features

- Integrated directional short-circuit and directional earth fault indicator
- Acquisition and transmission of faults and data
- Continuous phase-selective load monitoring and load flow direction monitoring, P, Q, S, cos φ, E
- Retrofittable, easy and quick installation
- Bidirectional data transfer to iHost

The ComPass BX12 is a compact solution, combining a directional short-circuit and directional earth fault indicator with an integrated RTU.

The voltage is measured by an integrated voltage detecting system like Wega. Voltage tapping is also possible via HR interfaces or on divider insulators with capacitive coupling (set of measuring cables).

Reported short-circuits, earth faults and measuring values are sent to the secure iHost system. This feature helps utilities to improve their efficiency by reducing outage times in the distribution system in order to increase system reliability.

In addition, this remote underground monitoring solution provides important grid parameters from the medium voltage network, e. g. phase selective current load flow, transmitted to the control room. This will have a major impact in the future for event history allocation, interactive trend graphs and GIS map integration.

Utilities are able to analyse and evaluate a variety of information, leading to better understanding and management of complex underground medium voltage networks.

Furthermore the utilities will be able to be more pro-active in preventing incidents.



Technical data	ComPass BX12
I>> short-circuit trip current	20–2,000 A (1 A steps)
tI>> response delay	40 ms–60 s (10 ms steps)
I>E> earth fault trip current	20–1,000 A (1 A steps) (low-impedance/solidly earthed network) 5–200 A (1 A steps) (isolated/compensated network)
tI>E> response delay	40 ms–60 s
V> overvoltage trip values	100 %–200 %
V< undervoltage trip values	0 %–100 %
Measured values / indication	<ul style="list-style-type: none"> Phase currents I₁, I₂, I₃, I_E with phase angle Phase-to-earth voltage V₁, V₂, V₃, V_{NE} and phase-to-phase voltage V₁₂, V₂₃, V₃₁, V_{NE} Load flow direction A↑ or B↓ S, P, Q and cos φ (S_{1,2,3}, P_{1,2,3}, Q_{1,2,3}, cos φ_{1,2,3}) Effective energy (E1A, E2A, E3A, EA, E1B, E2B, E3B, EB) Operating current, I₁, I₂, I₃, I_E 15 min, I₁, I₂, I₃ max. 24 h/7 days/365 days Maximum demand indicator I max. LR (last reset) I₁, I₂, I₃ Frequency f
Measurement accuracy phase currents	3 % (0–630 A, resolution 1 A) 5 % (630–1,500 A) 10 % (1,500–2,000 A)
Indication	<ul style="list-style-type: none"> LED status display (multicolour) OLED display (multicolour)
Remote signal / communication	<ul style="list-style-type: none"> 4 potential-free relay contacts, freely configurable RS485 / Modbus interface
Remote contact	4 potential-free permanent or momentary contacts (1 s), NC or NO Contact capacity: 230 V AC / 1 A / 62.5 VA max.; 220 V DC / 1 A / 60 W max.
Reset	<ul style="list-style-type: none"> By rocker switch Automatic time reset: 1 min–24 h Remote reset Via RS485 / Modbus interface Current restoration Restoration of auxiliary supply Voltage restoration
Event history	<ul style="list-style-type: none"> Last 20 events locally Unlimited in iHost
Special features	<ul style="list-style-type: none"> Routine call Automatic date and time synchronisation Transmission of signal field strength Temperature sensor
Inputs	<ul style="list-style-type: none"> 16 digital inputs (hardware) 8 analogue inputs (4–20 mA) (hardware) 63 Modbus (digital) – 47 if hardware inputs are used 68 Modbus (analogue) – 60 if hardware inputs are used
Interfaces	Modbus
Communication	Bidirectional data connection to iHost
Power supply	
Internal power supply	Back-up battery, max. 48 h
External auxiliary supply	85–264 V (50–60 Hz)
Housing	Glass fibre reinforced polyester, IP66
Installation	Wall mounting
Temperature range	–20 to +65 °C

Dimension drawing see on page 159, M13

Equipment set	Page
1 remote monitoring box	Order no. V28-7502-052-001
ComPass BX12 with 1 ComPass B	
3 single-phase current sensors (10 m cable)	
1 voltage signal	52
1 iHost solution	
iHost Cloud	82
iHost Compact	82
iHost Solo	84
iHost Pro	84

Product matrix on page 78

Radio Reporter 2.0

Remote monitoring of Navigator LM Radio to iHost



Radio Reporter 2.0

Product features

- Detection and transmission of signals as received from overhead FCIs type Navigator LM Radio
- Transfer via bidirectional data connection to iHost
- Internal battery supply/ no auxiliary supply necessary

The Radio Reporter 2.0 is always used in combination with Navigators type LM Radio. Once a short-circuit has been detected, the Navigator starts flashing and transmits a radio signal to the Radio Reporter 2.0.

Due to the internal battery supply as well as the wide availability of the mobile network FCIs can be monitored in the whole distribution network.

The Radio Reporter 2.0 has a robust, weatherproof housing for pole-mounting. Quick and easy installation: install the Radio Reporter 2.0 to a pole, mount the Navigator LM Radio on the conductor and it's done.

Four different Navigator code configurations – A, B, C and D – permit either a group or phase-selective message and are provided onto four dedicated outputs. Moreover, the battery status of all Navigator LM Radio as well as the battery status of the Radio Reporter 2.0 are monitored. The Radio Reporter 2.0 can be configured using Windows-based PC software and iHost.

Reported short-circuits and earth faults are securely sent to SCADA via the iHost system and can be retrieved by any web-enabled device at any time. Notifications can also be received by e-mail and/or SMS.



Technical data	Radio Reporter 2.0
Special features	<ul style="list-style-type: none"> ▪ Routine call ▪ Automatic date and time synchronisation ▪ Transmission of signal field strength ▪ Temperature sensor ▪ Fault and status notification via SMS and/or e-mail
Communication	<ul style="list-style-type: none"> ▪ Coded fault information from overhead faulted circuit indicator Navigator LM Radio ▪ Bidirectional data connection to iHost
Indication	Control LEDs for data reception/connection/fault indicators (jumper to activate the internal indication during commissioning)
Power supply	Replaceable long-life lithium cell 7–10 years, min. 1,000 calls
Housing	Glass fibre reinforced polycarbonate, IP66
Installation	Pole mounting
Temperature range	–30 to +70 °C

Dimension drawing see on page 159, M13

Equipment set	Page
1 Radio Reporter 2.0	Order no. 28-7101-022
3–12 Navigator LM Radio	68
1 iHost solution	
iHost Cloud	82
iHost Compact	82
iHost Solo	84
iHost Pro	84

Product matrix on page 78

Smart Reporter

Remote monitoring to SCADA



Smart Reporter

Product features

- Controls up to twelve Smart Navigator FCI's
 - Data transfer to SCADA
 - Remote and local configuration
 - Rechargeable back-up battery
 - Includes Smart PMU for intelligent power management
 - Tamper detection
- Provided Information
- Overhead line fault indication (permanent/momentary)
 - Overhead line de-energisation (loss of current alarms)
 - Average load current and actual load current
 - Peak load current (min and max)
 - Counters: permanent faults/momentary faults
 - Device temperature, conductor temperature (option)
 - Routine call and health check
 - Battery status

The Smart Reporter is a robust, pole mounted solution that interacts with the Horstmann Smart Navigator overhead FCI's. It provides information about events and fault locations for distribution and sub-transmission overhead lines. It provides information such as monitoring, fault indication, event history and fault locations for distribution and sub-transmission overhead lines.

The Smart Reporter acts as an access point that relays information from the Smart Navigators through different WAN environments like cellular, licensed/unlicensed radio, etc. into SCADA or network management systems.

Horstmann's intuitive and user friendly web-hosted application iHost provides network overview anytime – not only in case of outages. This solution helps utilities to improve their efficiency by reducing outage times in the distribution system and increase system reliability.

Technical data	Smart Reporter
Special features	<ul style="list-style-type: none"> ▪ Routine call ▪ Door contact switch for tamper detection ▪ Temperature sensor
Interfaces	<ul style="list-style-type: none"> ▪ 2 serial ports (RJ45, RS232) ▪ Ethernet RJ45 10/100 port for DNP3 IP or local access and configuration ▪ Mini USB for local access and configuration
Communication	<ul style="list-style-type: none"> ▪ Short range radio link controller for up to 12 Smart Navigator ▪ Bidirectional data connection to customer owned SCADA
Indication	Control LEDs for data reception/connection/fault indicators (jumper to activate the internal indication during commissioning)
Distance between FCI and Smart Reporter	30 m (line-of-sight)
Router/gateway	Cellular <ul style="list-style-type: none"> ▪ Sierra wireless raven XE ▪ Standard option: 2.5G/3G cellular; CDMA on request Other cellular on request
EMC	EN 61000-4
Power supply	
Internal power supply	Back-up battery, rechargeable
External auxiliary supply	85–264 V AC / 47–63 Hz / 120–370 V DC
Housing	Glass fibre reinforced polyester, IP66
Installation	Wall mounting
Temperature range	–30 to +70 °C

Dimension drawing see on page 160, M15

Equipment set	Page
1 remote monitoring box	
Smart Reporter Solar	Order no. 28-3130-001
Smart Reporter AC	Order no. 28-3131-001
3–12 overhead faulted circuit indicators	
Smart Navigator/Smart Navigator HV	70
Smart Navigator DFCI HV	72

Product matrix on page 78



Orion M1

Is there voltage or not? This is an elementary question, but it is vital to have a definite answer when service or maintenance staff are working on switchgears, power lines and electrical systems. In so doing, it is absolutely imperative to ensure that devices are only used for their approved nominal voltage and nominal frequency.

Horstmann solutions:

Voltage detectors and phase comparators

- For indoor and outdoor checks
- Visual and audible signals
- Highest safety thanks to self-test feature on selected models

Capacitive voltage detecting systems (VDS)

Capacitive voltage detecting systems can be divided up into two different design types. In the case of separable systems, a portable indicating device (e.g. HR-ST) is connected to the fixed built-in part of the VDS (e.g. an HR socket). As opposed to this, integrated systems (type Wega) are mounted permanently in the operating equipment or can be



Voltage detector BL-I/BL-A

retrofitted (Wega 1.2 C vario). They comprise the permanent indication of the voltage and are equipped with either an LRM interface or a measurement point for phase comparison. Thanks to the additional feature of a permanently supervised interface conditions displayed, no extra maintenance tests are required for these devices.

The Orion series: Orion 3.1 and M1 are portable testing devices that allow technicians to carry out on-site voltage detection, phase comparison and interface checks.

The products marked with an ePLAN logo are available in the ePLAN-data Portal with the circuit diagram and terminal assignment.

Product matrix

Integrated voltage detecting systems (VDS)



Function	Wega 1.2 C Page 102	Wega 1.2 C vario Page 104	Wega 2.2 C Page 106	Wega 3 Page 108	Wega LRM Page 109
3 phase VDS according to IEC 61243-5	■	■	■	■	based on IEC 61243-5
Capacitive voltage coupling for ComPass B series and Sigma D series	■	■	■	-	-
Overvoltage indication	■	■	■	-	-
Integrated permanent maintenance test	■	■	■	■	-
Integrated display test (without auxiliary supply)	■	■	■	-	-
Fully enclosed electronics	■	■	■	■	■
Adjustable C2 capacity	-	■	-	-	-
Assembly set for retrofit	-	■	-	-	-
Display					
LCD display/LED indication	■/-	■/-	■/■	■/-	-/-
Display powered by measured voltage	■	■	■	■	■
LCD symbols					
Voltage present Threshold value: 0.1–0.45 x Vnom	■	■	■	■	-
Voltage present Integrated maintenance test passed	■	■	■	■	-
Voltage present Integrated maintenance test passed Voltage signal too high (overvoltage)	■	■	■	-	-
Voltage not present	■	■	■	■	-
LRM interface					
Front accessible, fully featured LRM interface (L1/L2/L3)	■	■	■	Test point	■
Earth socket	■	■	■	■	■
Communication					
Relay contacts	-	-	■	-	-
Connections					
Flat connector	■	■	■	■	■
System connector (AMP)	■	■	■	■	■
Power supply					
External auxiliary supply	-	-	■	-	-

Product matrix

Voltage indicating systems for transformers and post insulators



Function	Wega T1 Page 112	Wega T1 vario Page 112
3 phase VDS according to IEC 61243-5	■	■
Capacitive voltage coupling for ComPass B series and Sigma D series	Coupling for transformers	Coupling for post insulators
Overvoltage indication	■	■
Integrated permanent maintenance test	■	■
Integrated display test (without auxiliary supply)	■	■
Fully enclosed electronics	■	■
Adjustable C2 capacity	-	■
Assembly set for retrofit	-	■
Display		
LCD display/LED indication	■/-	■/-
Display powered by measured voltage	■	■
LCD symbols		
Voltage present Threshold value: 0.1–0.45 x Vnom	■	■
Voltage present Integrated maintenance test passed	■	■
Voltage present Integrated maintenance test passed Voltage signal too high (overvoltage)	■	■
Voltage not present	■	■
LRM interface		
Front accessible, fully featured LRM interface (L1/L2/L3)	Test point	Test point
Earth socket	■	■
Communication		
Relay contacts	-	-
Connections		
Flat connector	■	■
System connector (AMP)	■	■
Power supply		
External auxiliary supply	-	-

Wega 1.2 C

Integrated voltage detecting system



Wega 1.2 C

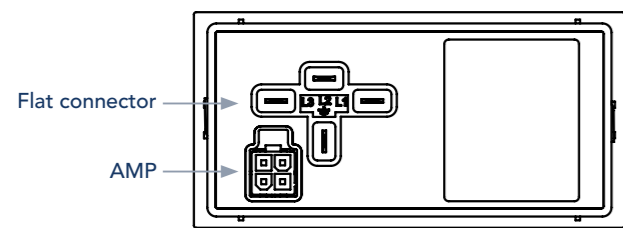

Back side

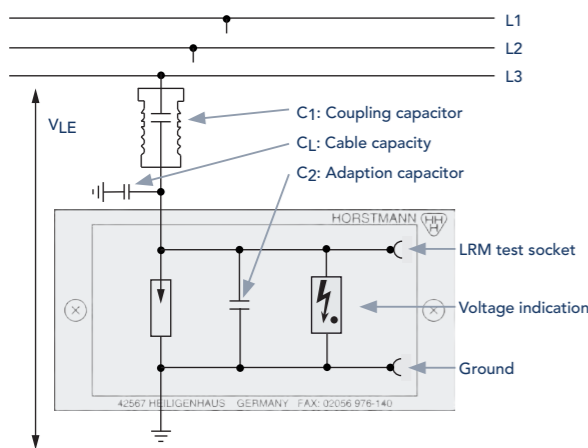

Principle of an integrated voltage detecting system

Product features

- Designed according to IEC 61243-5 (VDE 0682-415)
- Wide-range Wega (e.g. 10–20/24 kV):
Reduction of variants
- Integrated maintenance test: Maintenance-free
- Retrofit ready:
Capacitive connection to ComPass B and Sigma D series
- Front accessible LRM interface: Fully featured according to IEC 61243-5
- Fully enclosed electronics: High functional reliability
- Overvoltage indication: Phase-selective

Wega 1.2 C is a 3-phase voltage detecting system, which indicates the following operating voltage states:

- Voltage present
Threshold values for voltage presence indication:
0.1–0.45 x V_{nom}
- Voltage present
Integrated maintenance test passed
- Voltage present
Integrated maintenance test passed
Voltage signal too high (overvoltage indication)
- Voltage not present

The built-in display test function at the front enables verification of the display of the installed and de-energised unit.

For connection, either shielded or unshielded cables with flat connectors or system connectors can be used.

Technical data	Wega 1.2 C
Nominal voltage	1–52 kV (nominal voltage of switchgear, further values on request)
Nominal frequency	50–60 Hz
Interface	<ul style="list-style-type: none"> ■ 3 LRM measuring sockets (one per phase) and 1 earth socket ■ LRM system, 14 mm distance between sockets, with captive anti-dust cap
Indication	LCD display with arrow, dot and wrench tool
Power supply	<ul style="list-style-type: none"> ■ No auxiliary supply needed ■ LCD display: fed by measuring voltage
Housing	Polycarbonate, IP54
Temperature range	–25 to +65 °C

Dimension drawing see on page 160, M16
Product matrix on page 100



ABB	Switchgear	Switchgear panel	Voltage range	Input or output	Order no.
	SafeRing/SafePlus	Cable/transformer/circuit breaker	10–24 kV	Flat connector / AMP	V51-1250-120-004

Driescher	Switchgear	Switchgear panel	Voltage range	Input or output	Order no.
	Minex/Minex-C	Cable/transformer/circuit breaker	10–20 kV	Flat connector / AMP	51-1250-148

Eaton	Switchgear	Switchgear panel	Voltage range	Input or output	Order no.
	XIRIA	Cable/transformer/circuit breaker	10–20 kV	Flat connector / AMP	51-1250-125

Lucy Electric	Switchgear	Switchgear panel	Voltage range	Input or output	Order no.
	Aegis Plus	Circuit breaker	10–24 kV	Flat connector / AMP	51-1250-131
	Aegis Plus	Switch	10–24 kV	Flat connector / AMP	51-1250-121

Ormazabal	Switchgear	Switchgear panel	Voltage range	Input or output	Order no.
	ga/gae	Cable	10–20 kV	Flat connector / AMP	V51-1250-121-001
	ga/gae	Transformer	10–20 kV	Flat connector / AMP	V51-1250-101-001
	ga/gae	Circuit breaker 630	10–20 kV	Flat connector / AMP	V51-1250-129-001
	ga/gae	Circuit breaker 1250	10–20 kV	Flat connector / AMP	V51-1250-131-001
	ga/gae	Metering	10–20 kV	Flat connector / AMP	V51-1250-133-001

Schneider Electric	Switchgear	Switchgear panel	Voltage range	Input or output	Order no.
	FBX	C, C1, T1, R, RE	10–24 kV	Flat connector / AMP	51-1250-122
	FBX	T2, CB	10–24 kV	Flat connector / AMP	51-1250-132
	RM6	Cable/transformer	10–20 kV	Flat connector / AMP	51-1250-125

Siemens	Switchgear	Switchgear panel	Voltage range	Input or output	Order no.
	8DJH	Cable/transformer/circuit breaker	10–21.5 kV	Flat connector / AMP	51-1250-144

Required connection cable between Wega and directional fault indicator					
Switchgear	Output Wega/ Input indicator	Indicator	Cable length	Order no.	
ABB					
Eaton					
Lucy Electric	AMP / AMP	Sigma D and ComPass B 2.0 series	300 mm	49-0509-180	
Ormazabal					
Schneider Electric (RM6)					
ABB					
Eaton					
Lucy Electric	AMP / 4-pole connector	ComPass B	300 mm	49-0509-007	
Ormazabal					
Schneider Electric (RM6)					
Driescher	AMP / AMP	Sigma D and ComPass B 2.0 series	1,300 mm	49-0509-188	
Driescher	AMP / 4-pole connector	ComPass B	1,300 mm	49-0509-024	
Schneider Electric (FBX)	Flat connector / AMP	Sigma D and ComPass B 2.0 series	300 mm	49-0509-190	
Siemens (8DJH)					
Schneider Electric (FBX)	Flat connector / 4-pole connector	ComPass B	300 mm	49-0509-008	
Siemens (8DJH)					

Further switchgear types, manufacturer, voltage ranges and cable lengths on request.

Wega 1.2 C vario

Integrated voltage detecting system



Wega 1.2 C vario

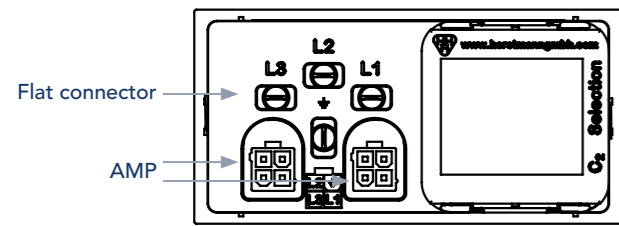

Back side

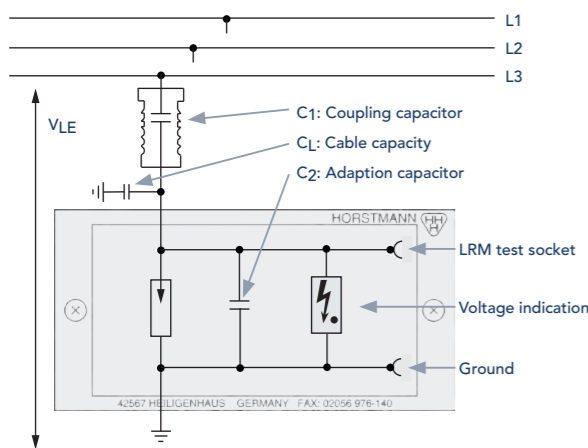

Principle of an integrated voltage detecting system

Product features

- Designed according to IEC 61243-5 (VDE 0682-415)
- Wide-range Wega (e.g. 10–20/24 kV):
Reduction of variants due to pluggable capacitor cube
- Integrated maintenance test: Maintenance-free
- Retrofit ready:
Capacitive connection to ComPass B and Sigma D series
- Front accessible LRM interface: Fully featured according to IEC 61243-5
- Fully enclosed electronics: High functional reliability
- Overvoltage indication: Phase-selective

Wega 1.2 C vario is a 3-phase voltage detecting system, which indicates the following operating voltage states:

- Voltage present
Threshold values for voltage presence indication:
0.1–0.45 x V_{nom}
- Voltage present
Integrated maintenance test passed
- Voltage present
Integrated maintenance test passed
Voltage signal too high (overvoltage indication)
- Voltage not present

Wega 1.2 C vario can be used to upgrade an HR interface to LRM interface.

The built-in display test function at the front enables verification of the display of the installed and de-energised unit. To ensure flexibility, an adjustable capacitor cube is plugged in on the back of the device allowing the use of various balancing capacitors. For connection, either shielded or unshielded cables with flat connectors or system connectors can be used.

Optional: Mounting kit consisting of support frame with magnet on the back along with connection cable for HR interface for easy attachment on the front face of switchgear units.

Technical data	Wega 1.2 C vario
Nominal voltage	1–52 kV (nominal voltage of switchgear, further values on request)
Nominal frequency	50–60 Hz
Interface	<ul style="list-style-type: none"> ■ 3 LRM measuring sockets (one per phase) and 1 earth socket ■ LRM system, 14 mm distance between sockets, with captive anti-dust cap
Indication	LCD display with arrow, dot and wrench tool
Power supply	<ul style="list-style-type: none"> ■ No auxiliary supply needed ■ LCD display: fed by measuring voltage
Housing	Polycarbonate, IP54
Temperature range	–25 to +65 °C

Dimension drawing see on page 160, M17

Product matrix on page 100



The following variants are only for new installations!

Switchgear	Switchgear panel	Voltage range	Input or output	Order no.
SafeRing/SafePlus	Cable/transformer/circuit breaker	10 kV, 20 kV	Flat connector / AMP	V51-1300-001-004

Switchgear	Switchgear panel	Voltage range	Input or output	Order no.
Minex/Minex-C	Cable/transformer	10 kV	Flat connector / AMP	V51-1300-001-161
Minex/Minex-C	Cable/transformer	20 kV	Flat connector / AMP	V51-1300-001-004
PSA-10/-20/-30	Cable	4.6–36 kV	Flat connector / AMP	V51-1300-001-101

Switchgear	Switchgear panel	Voltage range	Input or output	Order no.
XIRIA	Cable/transformer/circuit breaker	10–11 kV, 20–22 kV	Flat connector / AMP	V51-1300-001-121

Switchgear	Switchgear panel	Voltage range	Input or output	Order no.
Aegis Plus	Circuit breaker / switch	30–36 kV	Flat connector / AMP	V51-1300-001-002
Aegis 2	Circuit breaker / switch	7.2–36 kV / 7.2–26 kV	Flat connector / AMP	V51-1300-001-002

Switchgear	Switchgear panel	Voltage range	Input or output	Order no.
ga/gae	Cable/transformer	3–24 kV	Flat connector / AMP	V51-1300-001-151
ga/gae	Circuit breaker 630 A	10 kV	Flat connector / AMP	V51-1300-001-004
ga/gae	Circuit breaker 630 A	20 kV	Flat connector / AMP	V51-1300-001-155
ga/gae	Circuit breaker 1250 A/metering	10 kV, 20 kV	Flat connector / AMP	V51-1300-001-155

Switchgear	Switchgear panel	Voltage range	Input or output	Order no.
FBX	C, C1, T1, R, RE, T2, CB	3–30/34 kV	Flat connector / AMP	V51-1300-001-302
RM6	Cable/transformer	3–26 kV	Flat connector / AMP	V51-1300-001-301

Switchgear	Switchgear panel	Voltage range	Input or output	Order no.
8DJH	Cable/transformer/circuit breaker/metering	4.8–26 kV	Flat connector / AMP	V51-1300-001-201
NXPLUS C	Outside cone	10 kV, 20 kV	Flat connector / AMP	V51-1300-001-202

Required connection cable between Wega and directional fault indicator

Switchgear	Output Wega/ Input indicator	Indicator	Cable length	Order no.
ABB Eaton Lucy Electric Ormazabal Schneider Electric (RM6)	AMP / AMP	Sigma D and ComPass B 2.0 series	300 mm	49-0509-180
ABB Eaton Lucy Electric Ormazabal Schneider Electric (RM6)	AMP / 4-pole connector	ComPass B	300 mm	49-0509-007
Driescher	AMP / AMP	Sigma D and ComPass B 2.0 series	1,300 mm	49-0509-188
Driescher	AMP / 4-pole connector	ComPass B	1,300 mm	49-0509-024
Schneider Electric (FBX) Siemens	Flat connector / AMP	Sigma D and ComPass B 2.0 series	300 mm	49-0509-190
Schneider Electric (FBX) Siemens	Flat connector / 4-pole connector	ComPass B	300 mm	49-0509-008

Further switchgear types, manufacturer, voltage ranges and cable lengths on request.

Wega 2.2 C

Integrated voltage detecting system



Wega 2.2 C

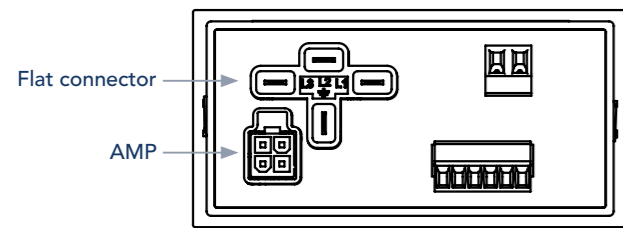

Back side

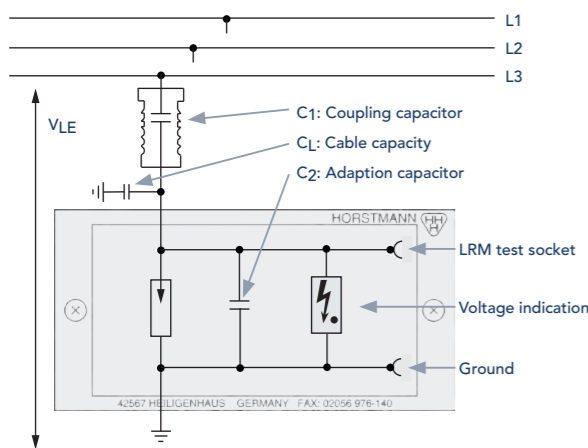

Principle of an integrated voltage detecting system

Product features

- Designed according to IEC 61243-5 (VDE 0682-415)
- Remote: two relay contacts
- Wide-range Wega (e. g. 10–20/24 kV): Reduction of variants
- Integrated maintenance test: Maintenance-free
- Retrofit ready:
Capacitive connection to ComPass B and Sigma D series
- Front accessible LRM interface: Fully featured according to IEC 61243-5
- Fully enclosed electronics: High functional reliability
- Overvoltage indication: Phase-selective

Wega 2.2 C is a 3-phase voltage detecting system, which indicates the following operating voltage states:

- Voltage present
Threshold values for voltage presence indication:
0.1–0.45 x Vnom
- Voltage present
Integrated maintenance test passed
- Voltage present
Integrated maintenance test passed
Voltage signal too high (overvoltage indication)
- Voltage not present

Additional to the LCD display the Wega 2.2 C has two LEDs (green U=0 and red U≠0). With two relay contacts the voltage state can be remotely monitored.

The built-in display test function at the front enables verification of the display of the installed and de-energised Wega 2.2 C.

For connection, either shielded or unshielded cables with flat connectors or system connectors can be used.

Technical data	Wega 2.2 C
Nominal voltage	1–52 kV (nominal voltage of switchgear, further values on request)
Nominal frequency	50–60 Hz
Interface	<ul style="list-style-type: none"> ■ 3 LRM measuring sockets (one per phase) and 1 earth socket ■ LRM system, 14 mm distance between sockets, with captive anti-dust cap
Indication	<ul style="list-style-type: none"> ■ LCD display with arrow, dot and wrench tool ■ LED indication, U=0 and U≠0
Remote signal	2 alternating relay contacts
Power supply	<ul style="list-style-type: none"> ■ LCD display: fed by measuring voltage ■ Relay and LEDs via 24–230 V AC/DC power supply
Housing	Polycarbonate, IP54
Temperature range	–25 to +65 °C

Dimension drawing see on page 160, M18

Product matrix on page 100



ABB	Switchgear	Switchgear panel	Voltage range	Input or output	Order no.
	SafeRing/SafePlus	Cable/transformer/circuit breaker	10–24 kV	Flat connector / AMP	V51-2250-105-004

Driescher	Switchgear	Switchgear panel	Voltage range	Input or output	Order no.
	Minex/Minex-C	Cable/transformer/circuit breaker	10–20 kV	Flat connector / AMP	51-2250-143

Eaton	Switchgear	Switchgear panel	Voltage range	Input or output	Order no.
	XIRIA	Cable/transformer/circuit breaker	10–20 kV	Flat connector / AMP	55-2250-116

Ormazabal	Switchgear	Switchgear panel	Voltage range	Input or output	Order no.
	ga/gae	Cable	10–20 kV	Flat connector / AMP	V51-2250-115-001
	ga/gae	Transformer	10–20 kV	Flat connector / AMP	V51-2250-106-001
	ga/gae	Circuit breaker 630	10–20 kV	Flat connector / AMP	V51-2250-119-001
	ga/gae	Circuit breaker 1250	10–20 kV	Flat connector / AMP	V51-2250-134-001

Schneider Electric	Switchgear	Switchgear panel	Voltage range	Input or output	Order no.
	FBX	C, C1, T1, R, RE	10–24 kV	Flat connector / AMP	51-2250-136
	FBX	T2, CB	10–24 kV	Flat connector / AMP	51-2250-139
	RM6	Cable/transformer	10–20 kV	Flat connector / AMP	51-2250-116

Siemens	Switchgear	Switchgear panel	Voltage range	Input or output	Order no.
	8DJH	Cable/transformer/circuit breaker	10–21.5 kV	Flat connector / AMP	51-2250-124

Required connection cable between Wega and directional fault indicator

Switchgear	Output Wega/ Input indicator	Indicator	Cable length	Order no.
ABB Eaton Lucy Electric Ormazabal Schneider Electric (RM6)	AMP / AMP	Sigma D and ComPass B 2.0 series	300 mm	49-0509-180
ABB Eaton Lucy Electric Ormazabal Schneider Electric (RM6)	AMP / 4-pole connector	ComPass B	300 mm	49-0509-007
Driescher	AMP / AMP	Sigma D and ComPass B 2.0 series	1,300 mm	49-0509-188
Driescher	AMP / 4-pole connector	ComPass B	1,300 mm	49-0509-024
Schneider Electric (FBX) Siemens	Flat connector / AMP	Sigma D and ComPass B 2.0 series	300 mm	49-0509-190
Schneider Electric (FBX) Siemens	Flat connector / 4-pole connector	ComPass B	300 mm	49-0509-008

Further switchgear types, manufacturer, voltage ranges and cable lengths on request.



Wega 3

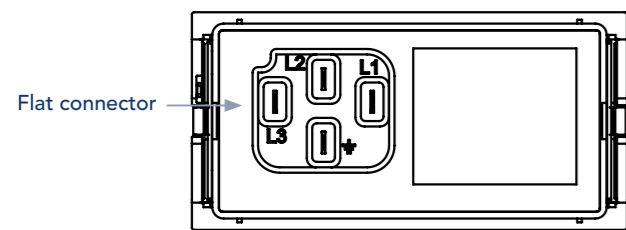



Back side

Product features

- Designed according to IEC 61243-5 (VDE 0682-415)
- Continuous LCD indication: 3-phase
- Integrated maintenance test: Maintenance-free
- Fully enclosed electronics: High functional reliability
- Tool-free assembly

Wega 3 is a 3-phase voltage detecting system, which indicates the following operating voltage states:

-  Voltage present
Threshold values for voltage presence indication: 0.1–0.45 x Vnom
-  Voltage present
Integrated maintenance test passed
-  Voltage not present

For connection, either shielded or unshielded cables with flat connectors or system connectors can be used.

Technical data	Wega 3
Nominal voltage	1–52 kV (nominal voltage of switchgear, further values on request)
Nominal frequency	50–60 Hz
Interface	Test point for each phase and 1 earth socket, with anti-dust cap
Indication	LCD display with arrow and dot
Power supply	<ul style="list-style-type: none"> ■ No auxiliary supply needed ■ LCD display: fed by measuring voltage
Housing	Polycarbonate, IP54
Temperature range	–25 to +65 °C

Dimension drawing see on page 160, M19
Product matrix on page 100

Ormazabal

Switchgear	Switchgear panel	Voltage range	Input	Order no.
ga/gae	Transformer	5–10 kV	Flat connector	V51-1410-001-106
ga/gae	Cable	5–10 kV	Flat connector	V51-1410-001-107
ga/gae	Circuit breaker 630 A	5–10 kV	Flat connector	V51-1410-001-108
ga/gae	Circuit breaker 1250 A	5–10 kV	Flat connector	V51-1410-001-109
ga/gae	Metering	5–10 kV	Flat connector	V51-1410-001-110
ga/gae	Transformer	10–20 kV	Flat connector	V51-1410-001-101
ga/gae	Cable	10–20 kV	Flat connector	V51-1410-001-102
ga/gae	Circuit breaker 630 A	10–20 kV	Flat connector	V51-1410-001-103
ga/gae	Circuit breaker 1250 A	10–20 kV	Flat connector	V51-1410-001-104
ga/gae	Metering	10–20 kV	Flat connector	V51-1410-001-105

Siemens

Switchgear	Switchgear panel	Voltage range	Input	Order no.
8DJH	Cable / transformer / circuit breaker	4.5–5.5 kV	4-pole connector	V51-1421-001-101
8DJH	Cable / transformer / circuit breaker	5.5–7.2 kV	4-pole connector	V51-1421-001-102
8DJH	Cable / transformer / circuit breaker	7.2–12 kV	4-pole connector	V51-1421-001-103
8DJH	Cable / transformer / circuit breaker	10–21.5 kV	4-pole connector	V51-1421-001-104
8DJH	Cable / transformer / circuit breaker	15–26 kV	4-pole connector	V51-1421-001-105

Further versions for different switchgear manufacturers as well as further capacity levels on request.



Wega LRM

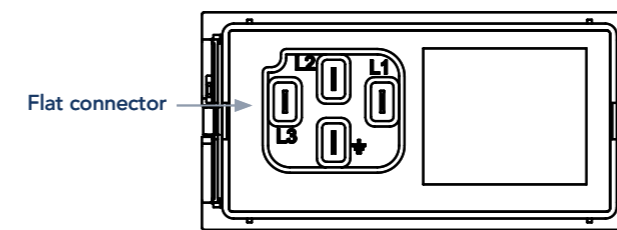

Back side

Product features

- Design based on IEC 61243-5 (VDE 0682-415)
- 3-phase voltage detecting system
- Front accessible LRM interface: Fully featured according to IEC 61243-5
- Fully enclosed electronics: High functional reliability
- Tool-free assembly

Technical data	Wega LRM
Nominal voltage	1–52 kV (nominal voltage of switchgear, further values on request)
Nominal frequency	50–60 Hz
Interface	<ul style="list-style-type: none"> ■ 3 LRM measuring sockets (one per phase) and 1 earth socket ■ LRM system, 14 mm distance between sockets, with anti-dust cap
Power supply	No auxiliary supply needed
Housing	Polycarbonate, IP54
Temperature range	–25 to +65 °C

Dimension drawing see on page 160, M19
Product matrix on page 100

Eaton

Switchgear	Switchgear panel	Voltage range	Input/Output	Order no.
XIRIA	Cable / transformer / circuit breaker	10–20 kV	Flat connector	51-1604-101

Ormazabal

Switchgear	Switchgear panel	Voltage range	Input/Output	Order no.
ga/gae	Cable	9–21 kV	Flat connector	51-1600-102
ga/gae	Transformer	9–21 kV	Flat connector	51-1600-101
ga/gae	Circuit breaker 630 A	9–21 kV	Flat connector	51-1600-103
ga/gae	Circuit breaker 1250 A	9–21 kV	Flat connector	51-1600-104
ga/gae	Metering	9–21 kV	Flat connector	51-1600-105

Further versions for different switchgear manufacturers as well as further capacity levels on request.

HR interface cable

For retrofitting HR jack modules

Wega 1.2 C vario to HR interface



Equipment set				
1 integrated voltage detecting system				
Wega 1.2 C vario without C2	Order no.	51-1300-001		
1 capacitor cube C2				
Capacitor cube "low range" 100/220/470/820 pF	Order no.	51-9100-101		
Capacitor cube "mid range" 1.5/3.3/6.8/15 nF	Order no.	51-9100-102		
Capacitor cube "high range" 22/33/68/68 nF	Order no.	51-9100-103		
1 Wega mounting kit incl. housing/magnet/connection cable				
300 mm cable	Order no.	51-1550-900		
500 mm cable	Order no.	51-1550-901		

Further cable lengths on request.

Set of connection cables between HR interface and ComPass B



ABB				
Switchgear	HR jack module	Voltage range	Cable length	Order no.
SafePlus	HR116	10–24 kV	2,000 mm	49-0509-012
SafeLink	Catu CL498	10 kV	2,000 mm	49-0509-013
SafePlus	HR113	6–12 kV	2,000 mm	49-0509-014
Driescher				
Switchgear	Year of construction	Voltage range	Cable length	Order no.
Minex-C	'03/'04/'06	10 kV, 11 kV	2,000 mm	49-0509-034
Minex-C	'03	20 kV	2,000 mm	49-0509-036
Ormazabal				
Switchgear	Year of construction	Voltage range	Cable length	Order no.
ga	'05	20 kV	2,000 mm	49-0509-012
ga	1998	10 kV	2,000 mm	49-0509-013
ga		20 kV	2,000 mm	49-0509-039
ga	'11	11 kV	2,000 mm	49-0509-014
Schneider				
Switchgear	Year of construction	Voltage range	Cable length	Order no.
RM6		20 kV	2,000 mm	49-0509-036
FBA/ FBX	'02/ '09	20 kV	2,000 mm	49-0509-013
Siemens				
Switchgear	Year of construction	Voltage range	Cable length	Order no.
8DJH		20 kV	2,000 mm	49-0509-013
8DJH20	'05	10–21.5 kV	2,000 mm	49-0509-015
8DJH40	'96	20 kV	2,000 mm	49-0509-031
8DJH20/40/H	'88/'95/'96/'99/ '08/'09/11	10 kV	2,000 mm	49-0509-036
8DJ10		11 kV	2,000 mm	49-0509-036

Further capacitive values and cable lengths on request.

PSA interface cable

For retrofitting air-insulated switchgears

Wega 1.2 C vario to capacitive post insulator C1Ix (see page 54)



Equipment set				
1 integrated voltage detecting system				
Wega 1.2 C vario without C2	Order no.	51-1300-001		
1 capacitor cube C2				
Capacitor cube for PSA 10/20/30	Order no.	51-9100-160		
3 coax cable				
3,000 mm	Order no.	49-6003-201		
5,000 mm	Order no.	49-6003-213		
6,000 mm	Order no.	49-6003-210		
7,500 mm	Order no.	49-6003-215		
10,000 mm	Order no.	49-6003-212		
1 earthing cable	Order no.	49-0511-002		

Further cable lengths on request.

Set of connection cables between capacitive post insulator C1Ix (see page 54) and Sigma D, Sigma D+, Sigma D++, ComPass B 2.0, ComPass Bs 2.0



Capacitive post insulator	Nominal voltage	Input indicator	Cable length	Order no.
C1I1-12 (PSA 10)	10 kV	AMP	8,000 mm	49-0509-245
C1I2-24 (PSA 20)	20 kV	AMP	4,000 mm	49-0509-246

Further capacitive values and cable lengths on request.

Set of connection cables between capacitive post insulator C1Ix (see page 54) and ComPass B



Capacitive post insulator	Nominal voltage	Input indicator	Cable length	Order no.
PSA 10	10 kV	4-pole connector	2,000 mm	49-0509-061
PSA 20	20 kV	4-pole connector	2,000 mm	49-0509-062

Further capacitive values and cable lengths on request.



Wega T1



Example of installation

Product features

- Designed according to IEC 61243-5 (VDE 0682-415)
- Continuous LCD indication: 3-phase
- Suitable for Euromold elbow connectors (K) 158 LR, (K) 152 SR and M 400 LR/G as well as Pfisterer MSCE 250 A with capacitive test points
- Integrated maintenance test: Maintenance-free

The Wega T1 is a 3-phase voltage detector for insulated medium voltage transformers safe for touching. It is installed in a surface mount housing for applications in new and existing transformer stations. Besides conventional medium voltage transformers, these types are in particular ideally suited for insulated medium voltage transformers, or in transformer stations/buildings with more than one transformer.

The built-in display test function at the front enables verification of the display of the installed and de-energised unit. The test points are not suitable for an LRM phase comparator due to the weak capacitive coupling which is associated with the specific application of the devices.

It indicates the following operating voltage states:

- Voltage present
Threshold values for voltage presence indication: 0.1–0.45 x Vnom
- Voltage present
Integrated maintenance test passed
- Voltage present
Integrated maintenance test passed
Voltage signal too high (overvoltage indication)
- Voltage not present

Technical data	Wega T1
Nominal voltage	1–52 kV (nominal voltage of transformer, further values on request)
Nominal frequency	50–60 Hz
Interface	Test points (1 per phase) and one earth socket, with captive anti-dust cap
Indication	LCD display with arrow, dot and wrench tool
Power supply	<ul style="list-style-type: none"> ■ No auxiliary supply needed ■ LCD display: fed by measuring voltage
Housing	Polycarbonate, IP54
Temperature range	–25 to +65 °C

Wega T1: Dimension drawing see on page 160, M20
Product matrix on page 101

Euromold			
Connector type	Voltage range	Order no.*	
(K) 152 SR/(K) 158 LR/M 400 LR/G	6–12 kV	V51-1251-001-301	
(K) 152 SR/(K) 158 LR/M 400 LR/G	10–20 kV	V51-1251-001-302	
(K) 152 SR/(K) 158 LR/M 400 LR/G	20–36 kV	V51-1251-001-303	

Pfisterer			
Connector type	Voltage range	Order no.*	
MSCE 250 A	10–20 kV	V51-1251-001-310	

*includes wall-mounted housing and cables.



Wega T1 vario

Product features

- Designed according to IEC 61243-5 (VDE 0682-415)
- Continuous LCD indication: 3-phase
- Suitable for voltage sensor C1A1-24
- Integrated maintenance test: Maintenance-free

The Wega T1 vario is a 3-phase voltage detector for connection to the voltage sensor C1A1-24. It can be installed in a surface mount housing for applications in new and existing transformer stations. To ensure flexibility, an adjustable capacitor cube is plugged in on the back allowing the use of various balancing capacitors. For connection, either shielded or unshielded cables with flat connectors or system connectors can be used.

The built-in display test function at the front enables verification of the display of the installed and de-energised unit.

The test points are not suitable for an LRM phase comparator due to the weak capacitive coupling which is associated with the specific application of the devices.

It indicates the following operating voltage states:

- Voltage present
Threshold values for voltage presence indication: 0.1–0.45 x Vnom
- Voltage present
Integrated maintenance test passed
- Voltage present
Integrated maintenance test passed
Voltage signal too high (overvoltage indication)
- Voltage not present

Technical data	Wega T1 vario
Nominal voltage	1–52 kV (nominal voltage of transformer, further values on request)
Nominal frequency	50–60 Hz
Interface	Test points (1 per phase) and one earth socket, with captive anti-dust cap
Indication	LCD display with arrow, dot and wrench tool
Power supply	<ul style="list-style-type: none"> ■ No auxiliary supply needed ■ LCD display: fed by measuring voltage
Housing	Polycarbonate, IP54
Temperature range	–25 to +65 °C

Wega T1 vario: Dimension drawing see on page 160, M17

Equipment set	Accessories	Order no.	Page
1 integrated voltage detector	Voltage sensor C1A1-24		54
Wega T1 vario without C2	Directional fault indicators	Order no. 51-1252-001	40
1 capacitor cube C2	Connection cable to fault indicator	49-0509-180	
Capacitor cube "low range" 100/220/470/820 pF	Wall-mounted housings	Order no. 51-9100-101	56

Product matrix on page 101

Orion 3.1 | Orion M1

Combined voltage detection and indication systems



Orion 3.1



Orion M1

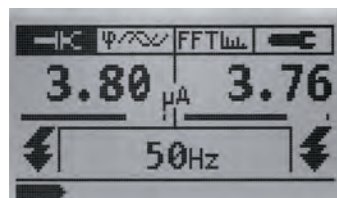

Indication capacitive interface

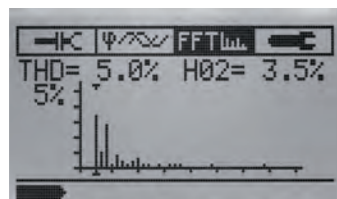

Indication voltage accuracy



Indication phase comparison

Product feature

- Designed according to IEC 61243-5 (VDE 0682-415)
- Voltage detector
- Phase comparator
- Interface detector
- Phase-sequence indicator with status RGB LED
- Orion M1 with additional functions
 - Voltage harmonics and interface current measurement
 - Phase angle measurement
 - LCD display
 - Measured data storage, readable
 - Data transmission via USB interface

Orion 3.1 and Orion M1 are testing and indication devices for voltage detecting, phase comparison and coupling part maintenance testing according to IEC 61243-5. They are used at LRM and HR interfaces in medium voltage switch-gears.

The Orion M1 features a large LCD display with back-light. It allows easy reading of the measured values, e. g. interface current, phase angle and voltage harmonics (according to EN 50160). The integrated USB interface is used to retrieve the stored data results for further evaluation.

Besides the information on the next maintenance test and the indication of the battery status, the Orion M1 device provides the user with menu language options (German/English) and option of setting the power frequency (16,7Hz / 50Hz / 60Hz).

Capacitive interface

- Precise current measurement in μA (2 x CH)
- Voltage testing symbols for both channels
- Maintenance tests
- Phase-sequence indication
- Frequency setting and battery status

Voltage accuracy

- FFT (Fast Fourier Transformation)
- Total harmonic distortion (THD) [%]
- Up to the 40th harmonic [%]
- Bar graph for voltage harmonics [%]

Phase characteristics

- Phase angle difference
- Phase balance / phase unbalance symbol
- Phase-sequence indication

According to the German accident prevention standard DGUV Regulation 3 (Table 1c), the device is subject to maintenance tests with minimum intervals of at least 6 years.

Technical data	Orion 3.1	Orion M1
Nominal frequency	50 or 60 Hz	16.7, 50, 60 Hz (adjustable)
Current measurement	—	Measuring range 1: 0–5 μA ($\pm 2\%$) Measuring range 2: 0–25 μA ($\pm 2\%$)
Phase angle measurement	—	Measuring range: -180° to $+180^\circ$ ($\pm 1^\circ$)
Harmonic voltage measurement	—	Bar graph: 0–5 % / 0–10 % THD: 0–100 % ($\pm 1\%$) Harmonic (2–40): 0–100 % ($\pm 1\%$)
Indication	RGB-LEDs	RGB LEDs LCD display
Power supply	4 mignon cells; replaceable 6 years of service life, 1,000 operating cycles/year	
Temperature range	-25 to $+55$ $^\circ\text{C}$	-25 to $+55$ $^\circ\text{C}$, below -15 $^\circ\text{C}$ LED indication only

Dimension drawing see on page 160, M21



Orion 3.1	Nominal frequency	Order no.
1 indication unit incl. plastic case, set of measuring lines, 2 HR/LRM adapter	50 Hz	51-0206-101
1 indication unit incl. plastic case, set of measuring lines, 2 HR/LRM adapter	60 Hz	51-0206-102



Orion M1	Nominal frequency	Order no.
1 indication unit incl. plastic case, set of measuring lines, 2 HR/LRM adapter, USB cable, CD with application software, magnetic holder	16.7, 50, 60 Hz	51-0206-201

Accessories



LR-LRM adapter
Order no. 52-0206-002



Weva adapter Orion, 104 mm
Order no. 10 kV 52-0206-004
Order no. 20 kV 52-0206-005



Weva adapter Orion, 130 mm
Order no. 10 kV 52-0206-014
Order no. 20 kV 52-0206-024



Special adapter HR
Cable length approx. 0.1 m
Order no. 52-0206-007



Special adapter Ivis
Set consists of 2 x red and 2 x black adapters
Cable length approx. 0.1 m
Order no. 52-0206-017



Magnetic holder
Part of the Orion M1 set
Order no. 49-6001-010



HR-ST



LRM-ST



Function tester HR/LRM-ST

Product feature

- Designed according to IEC 61243-5 (VDE 0682-415)
- HR-ST: Voltage indicator for high-resistance systems
- LRM-ST: Voltage indicator for low-resistance modified systems
- No battery supply
- Voltage present is indicated by a flashing LED
- Temporary or permanent use

HR-ST and LRM-ST type voltage indicators are portable parts of a voltage detecting system with capacitive single-pole coupling to live parts.

The HR/LRM function tester allows testing of the display and the overall function of the device.

According to the German accident prevention standard DGUV Regulation 3 (Table 1c), the device is subject to maintenance tests with minimum intervals of at least 6 years.

Technical data	HR-ST	LRM-ST
Response voltage V_t	70–90 V	4–5 V
Nominal frequency	50 Hz	
Input impedance	36.0–43.2 M Ω	2.0–2.4 M Ω
Flash frequency	≥1 Hz upon trip voltage	
Circuit	Sealed in cast resin, water-proof	
Housing	Polycarbonate, IP 54	
Temperature range	–25 to +55 °C	

HR-ST: Dimension drawing see on page 160, M22
LRM-ST: Dimension drawing see on page 161, M23

	Accessories	Order no.
HR-ST	Order no.	51-0205-010
LRM-ST	Order no.	51-0205-011
	Function tester	52-0211-007



Interface adapter converter



Case kit

Product feature

- Designed according to IEC 61243-5 (VDE 0682-415)
- Re-establishment of damaged HR interfaces
- Upgrading of interfaces to meet relevant standards
- Conversion from HR to LRM interface

The HR/LRM adapter converter provides a solution that allows to re-establish/upgrade 3-phase HR interfaces on medium voltage switchgears which fail to comply with requirements for interfaces according to the IEC 61243-5 standard.

In most cases, it is possible to convert an affected HR interface into an LRM interface by implementing specific adaptation measures so that it complies with IEC 61243-5.

Advantages: Measurement, evaluation and mounting can be performed directly on the switchgear installation during running operation without having to open the switchgear installation or switch off the line voltage.

Should, in the course of time, the HR-interface continue to change, the LRM interface can be upgraded at any time by repeating the four steps.

Technical data	Interface adapter converter
Entry side	HR interface, two 4 mm plugs, 19 mm distance
Exit side	LRM interface, two 4 mm sockets, 14 mm distance
Overtoltage protection	Surge arrester 90 V, suitable for LRM interface
Adaptation	Adjustment capacitor, dielectric strength 200 V
Installation depth	33 mm This installation depth must be available within the switchgear at the HR interface in order to install the interface converter HR/LRM permanently.

Dimension drawing see on page 161, M24

Case kit	Accessories	Order no.
„Standard“, incl. plastic case, digital multimeter “Amprobe 37XR-A”, HR module HO-M, LRM module NO-M, software, interface adapter converter HR/LRM with 10 pieces of each value: 68/100/150/680 pF and 1.0/1.5/2.2/3.3/4.7/6.8/10/15 nF	68 pF	51-0208-013
	100 pF	51-0208-014
	150 pF	51-0208-015
	680 pF	51-0208-001
	1,0 nF	51-0208-002
„Compact“, incl. plastic case, digital multimeter “Amprobe 37XR-A”, HR module HO-M, LRM module NO-M, software, interface adapter converter HR/LRM with 1 piece of each value: 68/100/150/680 pF and 1.0/1.5/2.2/3.3/4.7/6.8/10/15 nF	1,5 nF	51-0208-003
	2,2 nF	51-0208-004
	3,3 nF	51-0208-005
	4,7 nF	51-0208-006
	6,8 nF	51-0208-007
„Compact“, incl. plastic case, HR module HO-M, LRM module NO-M, software, interface adapter converter HR/LRM with 1 piece of each value: 68/100/150/680 pF and 1.0/1.5/2.2/3.3/4.7/6.8/10/15 nF	10,0 nF	51-0208-008
	15,0 nF	51-0208-009

Product matrix

Voltage detectors

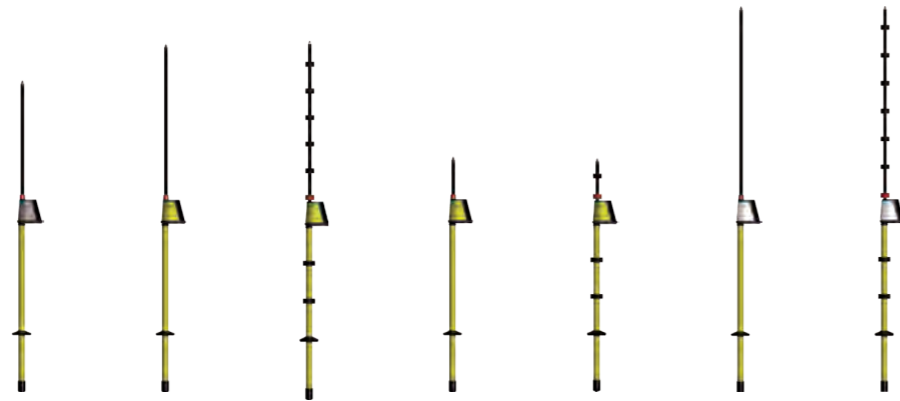

Function	FL-I Page 120	Comet BL-I Page 122	Comet BL-A Page 122	Comet BK-I Page 124	Comet BK-A Page 124	Comet BS-I Page 126	Comet BS-A Page 126
Environmental conditions							
Indoor*	■	■	■	■	■	■	■
Indoor and outdoor**	-	-	■	-	■	-	■
Self-test	-	■	■	■	■	■	■
Voltage indication							
Visual	■	■	■	■	■	■	■
Visual and audible	-	■	■	■	■	■	■
Nominal voltage [kV]							
5	-	■	■	-	-	-	-
6	■	-	-	-	-	-	-
10	■	■	■	-	-	-	-
20	■	■	■	-	-	-	-
5-10	-	-	-	-	-	-	-
6-10	-	■	■	■	■	■	■
10-20	-	■	■	■	■	■	■
20-30	-	■	■	-	-	-	-
Voltage range selectable	-	-	-	-	-	■	■
Dismountable	■	■	■	■	■	■	■

* Can be used outside, but not under wet conditions.
 ** Can be used under wet conditions.

Product matrix

Phase comparators

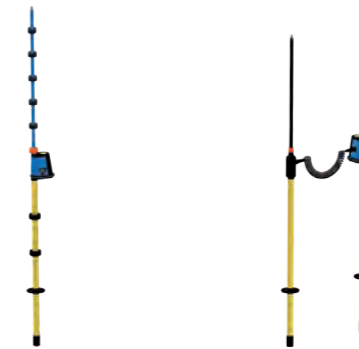

Function	Compare 2.0 Page 130	PG II Page 132
Environmental conditions		
Indoor*	■	■
Indoor and outdoor**	■	-
Self-test	■	-
Voltage indication		
Visual	■	■
Visual and audible	-	-
Nominal voltage [kV]		
5	-	■
6	-	■
10	-	■
20	-	■
30	-	■
5-10	■	-
10-20	■	■
20-36	■	-
Voltage range selectable	■	-
Dismountable	■	■

* Can be used outside, but not under wet conditions.
 ** Can be used under wet conditions.

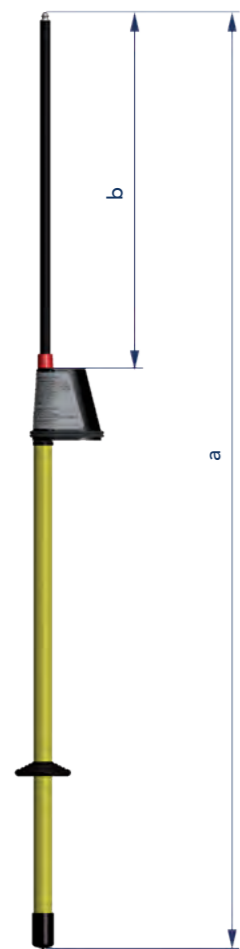

FL-I with indication unit

Product feature

- Designed according to IEC 61243-1 (VDE 0682-411), Category S
- Indoor type 🏠
- Visual voltage indication 👁️
- No battery

The FL-I device is a voltage detector for testing the voltage on one pole. This device is designed to detect operating voltages clearly indicating either the "voltage present" or "voltage not present" state. This device does not have a built-in power source (battery) and thus no self-test function. For transportation purposes, the insulating element can be removed from the display unit with the contact electrode. According to the German accident prevention standard DGUV Regulation 3 (Table 1c), the device is subject to maintenance tests with minimum intervals of at least 6 years.

Technical data	FL-I
Application	In dry conditions, normally indoors
Indication	3 red LEDs
Nominal frequency	50 Hz (optional 60 Hz)
Temperature range	-25 to +70 °C, climatic class N and W

Nominal voltage [kV]	Total length a [mm]	Insertion depth b [mm]	Order no.	Accessories	Page
6	1,270	463	50-1201-001	Extension rod	136
10	1,270	463	50-1201-002	Probe tip	136
20	1,370	563	50-1201-003	Universal plastic case	136

Product matrix on page 118



TP-I with indication unit

Product feature

- Design based on IEC 61243-1 (VDE 0682-411), Category S
- Indoor type 🏠
- Visual voltage indication 👁️
- No battery

The TP-I device is a two pole tester for capacitive test points on connectors in medium voltage switchgears with coupling capacities of 1.5 to 2.5 pF. This device determines the operating conditions of high voltage installations according to EN 50110-1 (DIN VDE 0105 Part 1 and 100). This device does not have a built-in power source (battery) and thus no self-test function.

For transportation purposes, the insulating element can be removed from the display unit with the contact electrode. According to the German accident prevention standard DGUV Regulation 3 (Table 1c), the device is subject to maintenance tests with minimum intervals of at least 6 years.

Technical data	TP-I
Application	In dry conditions, normally indoors
Indication	3 red LEDs
Nominal frequency	50 Hz
Temperature range	-25 to +70 °C, climatic class N and W

Nominal voltage [kV]	Total length a [mm]	Insertion depth b [mm]	Order no.	Accessories	Page
33	895	112	51-0201-004	Extension rod	136
6-10	895	112	51-0201-005	Probe tip	136
10-20	895	112	51-0201-003	Universal plastic case	136
20-36	895	112	51-0201-007		

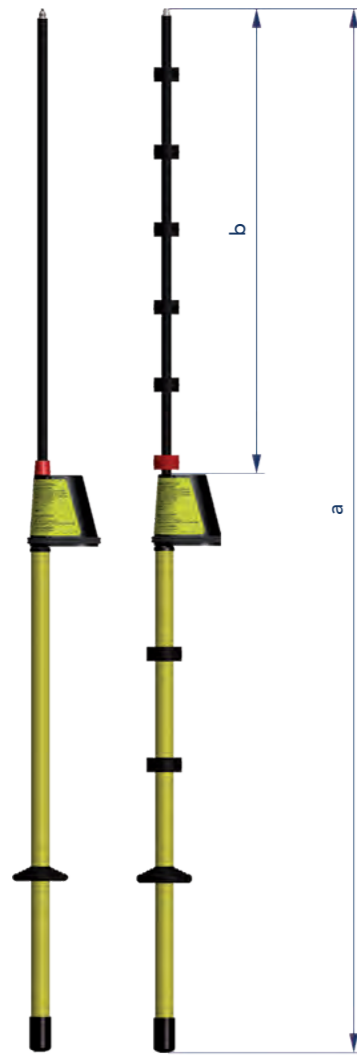

Comet BL-I | Comet BL-A

Voltage detector with self-test



Comet BL-I/BL-A with indication unit

Product feature

- Designed according to IEC 61243-1 (VDE 0682-411), category S
- Comet BL-I: indoor type 
- Comet BL-A: outdoor type 
- Voltage indication visual  or visual  and audible 
- Built-in self-test

The Comet BL-I/BL-A devices are capacitive voltage detectors for testing the voltage on one pole. They are intended for the detection of operating voltages clearly indicating either the "voltage present" or "voltage not present" state.

The voltage detectors are provided with a built-in self-test facility which checks the function of the circuit including the contact electrode (comprehensive self-test function) before each use.

For transportation purposes, the insulating element can be removed from the display with the contact electrode.

According to the German accident prevention standard DGUV Regulation 3 (Table 1c), the device is subject to maintenance tests with minimum intervals of at least 6 years.

Technical data	Comet BL-I	Comet BL-A
Application	In dry conditions, normally indoors	In dry and wet conditions, either indoors or outdoors
Indication	<ul style="list-style-type: none"> ■ Visual: 1 red LED / 1 green LED ■ Visual and audible: 1 red LED / 1 green LED / 1 buzzer 	
Nominal voltage	50 Hz (optional 60 Hz)	
Power supply	2 lithium cells, battery service life: 6 years based on 10 ready-to-operate cycles per day for a total of 230 work days per year	
Temperature range	-25 to +70 °C, climatic class N and W	

Nominal voltage [kV]	Total length a [mm]	Insertion depth b [mm]	Order no.			
			Comet BL-I 		Comet BL-A 	
						
5	1,270	462	50-0901-011	50-0903-008	50-1001-009	50-1003-009
10	1,270	462	50-0901-012	50-0903-009	50-1001-010	50-1003-010
20	1,420	612	50-0901-013	50-0903-010	50-1001-011	50-1003-011
6-10	1,420	612	50-0901-014	50-0903-011	50-1001-012	50-1003-012
10-20	1,570	762	50-0901-015	50-0903-012	50-1001-013	50-1003-013
20-30	1,570	762	50-0901-022	50-0903-018	50-1001-015	50-1003-018

Product matrix on page 118

Accessories	Page
Extension rod	136
Probe tip	136
Extension with contact electrode	136
Double prong adapter	136
Transportation bags	136

Comet BK-I | Comet BK-A

Voltage detector with self-test



Product feature

- Designed according to IEC 61243-1 (VDE 0682-411), category S
- Comet BK-I: indoor type 
- Comet BK-A: outdoor type 
- Voltage indication visual  or visual  and audible 
- Built-in self-test

The Comet BK-I/BK-A devices are capacitive voltage detectors for testing the voltage on one pole in short version. They are intended for the detection of operating voltages clearly indicating either the “voltage present” or “voltage not present” state.

The voltage detectors are provided with a built-in self-test facility which checks the function of the circuit including the contact electrode (comprehensive self-test function) before each use.

For transportation purposes, the insulating element can be removed from the display with the contact electrode.

According to the German accident prevention standard DGUV Regulation 3 (Table 1c), the device is subject to maintenance tests with minimum intervals of at least 6 years.



Comet BK-I/BK-A with indication unit

Technical data	Comet BK-I	Comet BK-A
Application	In dry conditions, normally indoors	In dry and wet conditions, either indoors or outdoors
Indication	<ul style="list-style-type: none"> ■ Visual: 1 red LED / 1 green LED ■ Visual and audible: 1 red LED / 1 green LED / 1 buzzer 	
Nominal voltage	50 Hz (optional 60 Hz)	
Power supply	2 lithium cells, battery service life: 6 years based on 10 ready-to-operate cycles per day for a total of 230 work days per year	
Temperature range	-25 to +70 °C, climatic class N and W	

Nominal voltage [kV]	Total length a [mm]	Insertion depth b [mm]	Order no.			
			Comet BK-I 		Comet BK-A 	
						
6-10	900	210	50-1301-001	50-1303-001	50-1401-001	50-1403-001
10-20	950	305	50-1301-002	50-1303-002	50-1401-002	50-1403-002

Product matrix on page 118

Accessories	Page
Extension rod	136
Probe tip	136
Extension with contact electrode	136
Double prong adapter	136
Transportation bags	136



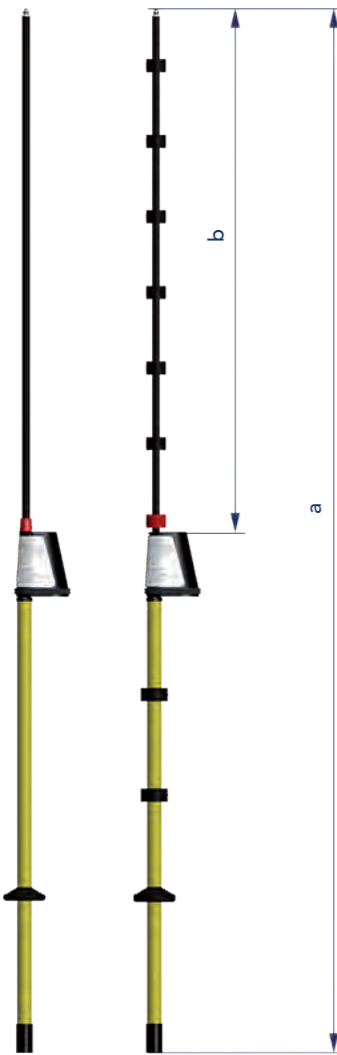

Comet BS-I | Comet BS-A

Voltage detector with self-test, voltage range selector



Comet BS-I/BS-A with indication unit

Product feature

- Designed according to IEC 61243-1 (VDE 0682-411), category S
- Voltage detector for nominal voltages from 5–30 kV, switchable
- Comet BS-I: indoor type 
- Comet BS-A: outdoor type 
- Voltage indication visual  or visual  and audible 
- Built-in self-test

Comet BS-I/BS-A devices are switchable single-pole voltage detectors. They are designed to detect operating voltages clearly indicating the “voltage present” or “voltage not present” state.

The voltage detectors are provided with a built-in self-test facility which checks the function of the circuit including the contact electrode (comprehensive self-test function) before each use.

The turning knob is used to select between three nominal voltage ranges:

- 0: OFF
- 1: 5–10 kV
- 2: 10–20 kV
- 3: 20–30 kV

For transportation purposes, the insulating element can be removed from the display unit with the contact electrode.

According to the German accident prevention standard DGUV Regulation 3 (Table 1c), the device is subject to maintenance tests with minimum intervals of at least 6 years.

Technical data	Comet BS-I	Comet BS-A
Application	In dry conditions, normally indoors	In dry and wet conditions, either indoors or outdoors
Indication	<ul style="list-style-type: none"> ■ Visual: 1 red LED / 1 green LED ■ Visual and audible: 1 red LED / 1 green LED / 1 buzzer 	
Nominal voltage	50 Hz (optional 60 Hz)	
Power supply	2 lithium cells, battery service life: 6 years based on 10 ready-to-operate cycles per day for a total of 230 work days per year	
Temperature range	–25 to +70 °C, climatic class N and W	

Nominal voltage [kV]	Total length a [mm]	Insertion depth b [mm]	Order no.			
			Comet BS-I 	Comet BS-A 		
5–30	1,570	758	50-0921-001 	50-0923-001 	50-1021-001 	50-1023-001 

Product matrix on page 118

Accessories	Page
Extension rod	136
Probe tip	136
Extension with contact electrode	136
Double prong adapter	136
Transportation bags	136

BO-A 2.0

For railway overhead contact lines



BO-A 2.0

Product feature

- VDE version – according to DIN VDE 0681-6
IEC version – based on IEC 61243-1 category S
- Pluggable system – minimal setup
- Integrated self-test – greater safety
- Light weight – easy handling and transportation
- Length of 4.7 m – voltage detection from the ground

The BO-A 2.0 is a voltage detector for medium voltage railway overhead contact lines. It is designed to detect the absence or presence of voltage during maintenance work for example. The voltage detector BO-A 2.0 is developed for 16.7 Hz, 50 Hz and 60 Hz networks. If the voltage detector BO-A 2.0 is used in network with a deviating frequency, a visual and audible signal is activated. In this case the network situation must be verified.

The BO-A 2.0 is designed according to IEC 61243-1 resp. VDE 0681-6, depending on the version. The voltage detector is ready for the worldwide market.

According to the German accident prevention standard DGUV Regulation 3 (Table 1c), the device is subject to maintenance tests with minimum intervals of at least 6 years.

Technical data	BO-A 2.0
Application	In dry and wet conditions
Indication	"Ready-to-operate state": green LED (after passed self-test) "Voltage present": red LED and audible signal "Voltage not present": green LED and no audible signal
Period of "Stand-by state"	65 s ±15 s
Type of indication	According to group III IEC 61243-1
Nominal voltage / nominal frequency	VDE version: 11 kV/16.7 Hz or 15 kV/16.7 Hz IEC version: 15 kV/16.7 Hz, 25 kV/50 Hz or 25 kV/60 Hz
Properties of the insulating rod	Passed test as insulating element for leakage current at 1.2 x Vr for 1 min
Power supply	Lithium cells, battery service life: 6 years based on 10 ready-to-operate cycles per day for a total of 230 work days per year
Transportation length	<1,111 mm
Minimum length insulating element	>520 mm
Transportation bag	1,130 x 340 x 100 mm (L x H x D)
Temperature range	-25 to +70 °C, climatic class N and W

Nominal voltage [kV]/ nominal frequency [Hz]	Total length a [mm]	Insertion depth b [mm]	Order no. ¹⁾	
			BO-A 2.0 (VDE version) 🏠 🌧️ 👁️ 🔊	BO-A 2.0 (IEC version) 🏠 🌧️ 👁️ 🔊
11/16,7	4,700	1,790	50-1510-001	–
15/16,7	4,700	1,790	50-1510-002	–
15/16,7	4,700	1,790	–	50-1511-001
25/50	4,700	1,790	–	50-1511-002
25/50	4,700	1,790	–	50-1511-003

1) Includes the transportation bag.



Transportation bag with BO-A 2.0

Compare 2.0

Phase comparator, single-pole

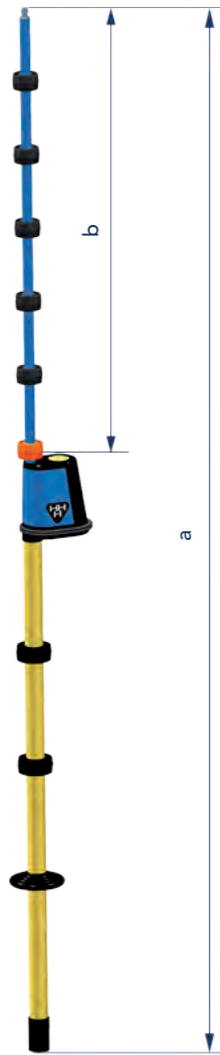

Compare 2.0 with indication unit

Product feature

- Designed according to IEC 61481 (VDE 0682-431)
- Single-pole, capacitive phase comparator
- Detection of correct phase relationship and incorrect phase relationship between two live conductors
- For indoor and outdoor applications 🏠 🌧️
- Visual indication 👁️
- Built-in self-test function

The phase comparator Compare 2.0 is a single-pole, capacitive phase comparator for voltages from 5–36 kV. The device detects “correct phase relationship” or “incorrect phase relationship” conditions between two live conductors of a medium voltage distribution network.

Confirming to IEC 61481 Class B, “incorrect phase relationship” appears at a phase angle between 60° and 300°.

Four bright LEDs indicate various operational conditions.

The turning knob is used to select between three voltage ranges:

- 1: 5–10 kV
- 2: 10–20 kV
- 3: 20–36 kV

The phase comparison is realised by contacting the conductors one after the other.

In medium voltage networks with decentralised renewable energy feed-ins, measurement interruptions may occur. In such cases repeat the phase comparison. It is impossible to get a wrong indication.

According to the German accident prevention standard DGUV Regulation 3 (Table 1c), the device is subject to maintenance tests with minimum intervals of at least 6 years.

Technical data	Compare 2.0
Application	In dry and wet conditions, either indoors or outdoors
Indication	Visual: 1 white LED/1 blue LED /1 green LED/ 1 red LED
Nominal frequency	50 Hz
Power supply	2 lithium cells, battery service life: 6 years based on 10 ready-to-operate cycles per day for a total of 230 work days per year
Operating class	B (indication of phase unbalance in the range of 60°–300°)
Temperature range	–25 to +70 °C, climatic class N and W

Nominal voltage [kV]	Total length a [mm]	Insertion depth b [mm]	Order no.	Accessories	Page
5–36	1,420	635	51-0104-001	Transportation bags	136

Product matrix on page 119

PG II

Phase comparator, two-pole

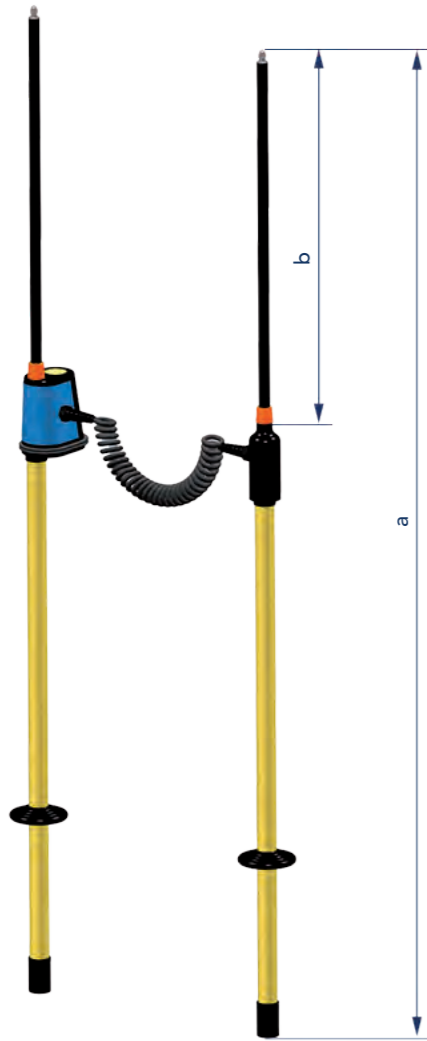

PG II with indication unit

Product feature

- Designed according to IEC 61481 (VDE 0682-431)
- Two-pole phase comparator
- Detection of correct phase relationship and incorrect phase relationship of two live conductors
- Indoor type 🏠
- Visual indication 👁️

PG II two-pole testing devices detect phase balance between two live conductors of a medium voltage distribution network.

The device consists of an operating stick with contact electrode and an indication unit (part A) as well as an operating stick with contact electrode (part B) to tap a comparative phase.

The insulated stick can be removed from the indication unit with the contact electrode.

Contact electrode A is directly connected with the contact electrode B using a helix cable suitable for high voltages.

According to the German accident prevention standard DGUV Regulation 3 (Table 1c), the device is subject to maintenance tests with minimum intervals of at least 6 years.

Technical data	PG II
Application	In dry conditions, normally indoors
Indication	Visual: 3 red LEDs
Nominal frequency	50 Hz (optional 60 Hz)
Maximum operating period with the pole connected to voltage	60 s
Connection cable	1 m
Operational class	B (indication of phase unbalance in the range of 60°–300°)
Temperature range	–25 to +70 °C, climatic class N and W

Nominal voltage [kV]	Total length a [mm]	Insertion depth b [mm]	Order no.	Accessories	Page
5	1.220	413	51-0102-001	Probe tip	136
6	1.220	413	51-0102-002	Transportation bags	136
10	1.220	413	51-0102-003		
20	1.320	513	51-0102-004		
30	1.420	613	51-0102-005		
10–20	1.320	513	51-0102-011		

Product matrix on page 118

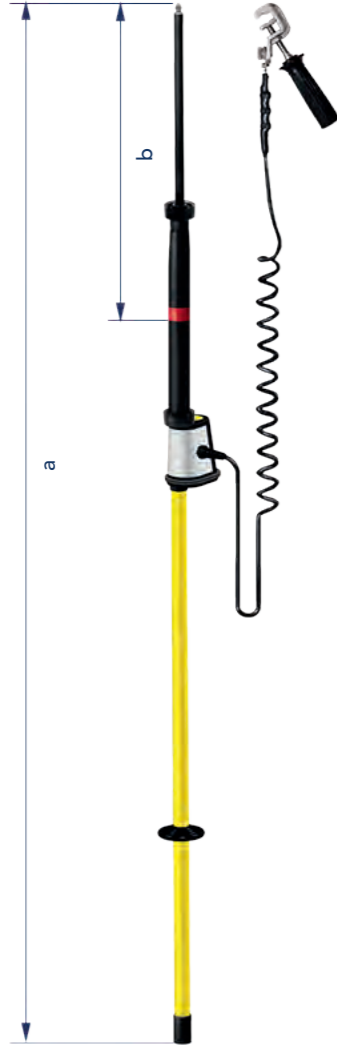

BL-M with indication unit



Bag set

Product feature

- 2-pole resistive voltmeter
- Designed for direct measurement of alternating voltages in medium voltage distribution networks of 10–24 kV/50 Hz
- Accuracy >99 %
- Application on medium voltage switchgears, transformers

The two-pole resistive BL-M type voltmeter is designed to precisely and directly measure phase-to-earth voltages in three-phase medium voltage distribution networks of 10–24 kV/50 Hz. Measured voltages are digitally displayed up to 19.99 kV. Thanks to its accurate measurement feature, the BL-M device can also be used for voltage calibration.

The device is designed and built in accordance with IEC 61243-2. It is intended for the use on switchgears, transformers and other medium voltage applications. This device can not be used as voltage detector according to EN 50110-1!

The structural design is based on the proven BL series voltage detectors which have been providing many years of reliable service. As with the predecessor model, the BL-M device offers the user easy and advantageous handling, dismantling and transportation capabilities.

A calibration and maintenance test is recommended on the basis of IEC 61243-2 in a cycle of 2 years.

Technical data	BL-M
Application	In dry conditions, normally indoors
Indication	Display
Nominal frequency	50–60 Hz (optional 16,7 Hz)
Measuring range	0.01 – 19.99 kV AC (RMS)
Resolution	0.01 kV
Measurement uncertainty	±1 %, ±1 digit
Power supply	Lithium cell
Duty cycle	10 min.
Total length (a)	2,340 mm
Insertion depth (b)	Approx. 570 mm
Earthing connection cable	Length: 3 m
Earthing terminal	Screw-type terminal
Temperature range	0 to +50 °C

Equipment set	Page	Accessories	Page
BL-M with connection cable and screw-type terminal, incl. universal plastic case, extension rod, test prod and double prong adapter	Order no. V99-0000-124-001	Extension rod	136
BL-M with connection cable and screw-type terminal	Order no. 99-0000-124	Probe tip	136
		Double prong adapter	136
		Transportation bags	136

Transportation bag



For products	Dimensions [mm]		Order no.
	L	H	
FL-I, Comet BL-I/BL-A, Comet BK-I/BK-A, Compare 2.0	900	200	52-0104-101
TP-I, Comet BS-I/BS-A	1,080	220	52-0104-102

Universal plastic case



For products	Dimensions [mm]			Order no.
	L	H	D	
FL-I, TP-I, Comet series, Compare 2.0, PG II	1,030	240	100	52-0102-001
BL-M	1,030	240	100	52-0102-005

Extension rod

For extending the handle



For products	Length [mm]	Order no.
FL-I, Comet series, Compare 2.0, PG II, BL-M	500	52-0108-013
FL-I, Comet series, Compare 2.0, PG II, BL-M	1,000	52-0108-014

Probe tip

The probe tip provides improved penetration into oxide and paint layers.



For products	Order no.
FL-I, Comet series, Compare 2.0, PG II, BL-M	52-0306-002

Extension rod with contact electrode

For extending the insertion depth. It is not allowed to use the extension with contact electrode when it is wet.



For products	Length [mm]	Effective length [mm]	Order no.
Comet BK-I/BK-A (6–10 kV)	750	670	52-0106-016
Comet BK-I/BK-A (10–20 kV)	800	720	52-0106-017

Further extensions with contact electrode for specific installation on request

Double prong adapter

The double prong adapter provides improved handling of voltage detectors/voltmeters for contacting surfaces and holding the device.



For	Order no.
Overhead lines	52-0307-001
Switchgear units and overhead lines	52-0307-003

As per German accident prevention regulations for electrical installations and equipment (DGUV Regulation 3) of Employers Liability Insurance Association, voltage detectors, phase comparators and pluggable capacitive voltage detecting systems are subject to maintenance tests at intervals not exceeding 6 years. Dipl. Ing. H. Horstmann GmbH offers this maintenance testing for all new but also for some older devices of own production.

Regardless of the duty to perform maintenance testing, the following rule is mandatory for devices and equipment including voltage detectors: The user is responsible for the safe and proper condition of the devices. Prior to each use, the user must verify devices and equipment are suitable for proper function as well as checking for externally visible damages and defects. Integrated capacitive voltage testing devices of the Wega series including Wega 1.2, Wega 1.2 C, Wega 2.2, Wega 2.2 C, Wega 1.2 C vario, Wega 3 and Wega T1 with self-test facility, are not subject to maintenance tests.

Maintenance test on devices belonging to the AC and FGB series are no longer carried out. In exchange, we offer corresponding new devices.

	Testing requirements according to	Remark	Age ≤14 years Order no.	Age ≥14 years and ≤24 years Order no.
Voltage detectors with capacitive coupling a)				
BL-I, BL-A	IEC 61243-1	a), b), c)	79-0102-004	79-0102-006
BK-I, BK-A, BS-I, BS-A	IEC 61243-1	a), b), c)	79-0102-004	79-0102-007
BO-A (for railway systems)	DIN VDE 0681 part 6	a), b), c)	79-0114-001	79-0114-005
FL-I	IEC 61243-1	a), b)	79-0110-001	79-0110-005
TP-I	Based on IEC 61243-1	a), b)	79-0113-001 (6–20 kV) 79-0113-002 (20–36 kV)	79-0113-005 (6–20 kV) 79-0113-006 (20–36 kV)
Phase comparators with capacitive coupling				
PG	IEC 61481		79-0105-000	—
PG II	IEC 61481	a), b), c)	79-0105-001	79-0105-005
Compare 2.0	IEC 61481	a), b), c)	79-0112-001	79-0112-005
Interface detectors, voltage detectors, phase comparators, measurement modules				
Orion 3.0	IEC 61243-5	b), c)	79-0107-001	79-0107-004
Orion 3.1	IEC 61243-5	c)	79-0107-002	79-0107-005
Orion M1	IEC 61243-5	c)	79-0107-003	79-0107-006
HO-M, NO-M	IEC 61243-5		79-0103-001	—
Capacitive continuous voltage indicators, pluggable a)				
HR-ST, LRM-ST	IEC 61243-5	d)	—	—
HO-ST, NO-ST	IEC 61243-5	e)	—	—
Coupling parts of pluggable capacitive voltage detecting systems				
HR or LRM interface (Alternatively: HR or LRM jack modules)	IEC 61243-5 (latest and newer devices)	f)	—	—
Voltmeter				
BL-M	Based on IEC 61243-2	g)	79-0107-020	79-0107-020

- a) All devices, which are sent to us by our customers, must be sent complete, including operating sticks and extension elements.
- b) We perform maintenance test only on the condition that the devices are not older than 24 years and in a technically acceptable condition. For devices with an age >14 and ≤24 years, an extended maintenance test will be performed, including electronics replacement.
- c) For all battery-operated devices, the battery replacement is mandatory during maintenance test (included in the price).
- d) Due to the disproportionately high testing expenditure, we do not carry out maintenance tests, but we offer "old" versus "new". Here we grant a special discount of 20 % on the new price if the old devices are sent back.
- e) Due to the disproportionately high testing expenditure, we do not carry out maintenance tests on HO-ST/NO-ST, but we offer new devices HR-ST/LRM-ST.
- f) Can be carried out on own initiative with the Orion 3.0, 3.1, M1. Orion 3.0, 3.1 conclude a good/bad condition. Further quantitative measurements can be carried out using HO-M and NO-M measuring adapters as well as appropriate digital multimeters.
- g) This test includes a metrological recalibration and maintenance test based on DIN EN 691243-2. We recommend the test every 2 years.

In order to avoid any delay in processing order, we kindly ask you to either attach a copy of your order letter to your consignment, or send us your order letter in due time.

Earthing devices and accessories

General information



Lengths of earthing and short-circuit cables have to fit to the switchgear and the distances between the connection points (min 1.2 times of the distance). If the cables are too long (>1.5 times of the distance) they must be fixed with an insulating cable to prevent damages and injuries in case of a short-circuit.

Earthing cables used on solidly earthed systems shall have the same cross-section as the associated short-circuiting cables or bars.

Earthing cables used on non-solidly earthed systems may have a cross-section less than the corresponding short-circuiting cables or bars.

Current and time rating for earthing equipment

When selecting the required cable cross section, the maximum short-circuit current of the switchgear installation must be taken into account. Connecting elements that are mounted to earthing and short-circuiting devices shall have at least the same current rating as the cables to which they are connected.

Earthing and short-circuiting devices and their components must be dimensioned in accordance with the short-circuit current rating (I_r), the short-circuit time rating (t_r) and the corresponding peak factor.

Type testing refers basically to a rated time $t_r = 0.5$ s.

Cable cross section [mm ²]	Short-circuit time $t_r = 0.5$ s		Short-circuit time $t_r = 1.0$ s	
	Rated current I_r [kA]	Peak factor	Rated current I_r [kA]	Peak factor
16	4.5	2.5	3.2	3.5
25	7.0	2.5	4.9	3.5
35	10.0	2.5	6.9	3.5
50	14.0	2.5	9.9	3.5
70	19.5	2.5	13.8	3.5
95	26.5	2.5	18.7	3.5
120	33.5	2.5	23.7	3.5
150	42.0	2.5	29.6	3.5

As a full-range supplier of medium voltage equipment, Horstmann offers a comprehensive and high-quality range of portable devices

- for temporary earthing or
- earthing and short-circuiting of disconnected or isolated switchgear.

This will prevent the occurrence of dangerous voltages or electric arcs if a system is re-closed accidentally or from coupling currents from adjacent systems.

The flexible Horstmann product range has a solution for almost every requirement.

Customised design in accordance with:

- Length of the cable
- Type of neutral earthing (whether or not solidly earthed)
- Rated short-circuit time
- Rated short-circuit current
- Rated short-circuit peak factor
- Required phase and earth connecting points

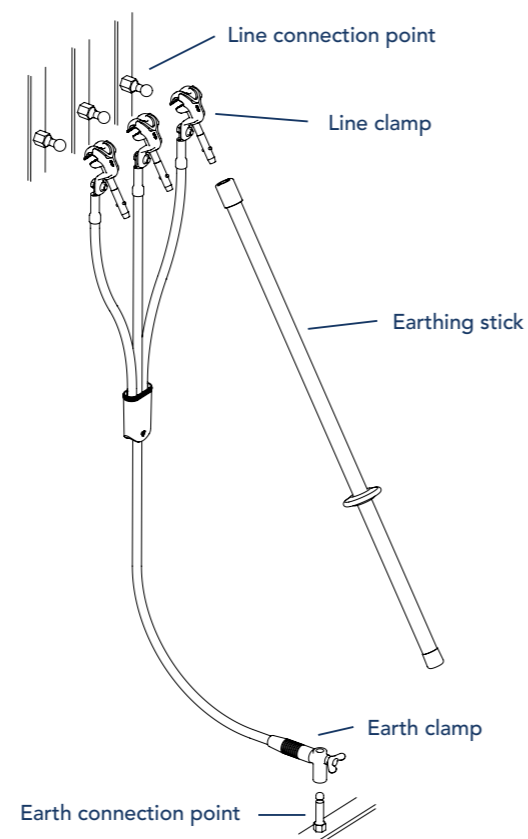

Earthing and short-circuiting devices

Three-phase device with ball tongs



Line cables with ball tong

Product features

- Designed according to IEC 61230 (VDE 0683-100)
- Cables assembled from highly flexible copper conductors (with transparent insulation)
- Moulded transparent connection piece allows permanent visual inspection
- Connection elements for phase cable: 3 ball tongs
- Connection elements for earth cable: M12 wing nut, M16 wing nut, earth clamp or earthing terminal
- Dimensions:
Distance between centre line of cable lug hole and entry of the connection piece:
Phase cable: 600 mm/550 mm/600 mm
Earth cable: 1,500 mm



Connection to: Fixed ball point Ø [mm]	Cable cross section, phase/earth cable [mm ²]	Rated values I _r [kA]/tr=1 s	Order no. of kit			
			Wing nut M12	Wing nut M16	Earth clamp	Earthing terminal
20	50/50	9.9	60-0108-002	–	60-0101-001	60-0107-001
20	70/35	13.8	60-0108-004	–	60-0101-003	60-0107-003
20	70/70	13.8	60-0108-003	60-0209-013	60-0101-002	60-0107-002
25	95/35	18.7	60-0208-002	60-0209-004	60-0201-001	60-0207-002
25	95/95	18.7	60-0208-001	60-0209-001	60-0202-001	60-0207-001
25	120/50	23.7	60-0208-003	60-0209-010	60-0201-002	60-0207-003
25	120/120	23.7	–	60-0209-002	60-0202-002	60-0207-007

Earthing and short-circuiting devices with other cable lengths and fittings for line or earth cable ends are available on request (see on page 169).

Accessories	Page
Hot sticks	151
Earthing sticks	150
Wall holders	155

Earthing and short-circuiting devices

Three-phase device with universal line clamp



Line cables with universal line clamp

Product features

- Designed according to IEC 61230 (VDE 0683-100)
- Cables assembled from highly flexible copper conductors (with transparent insulation)
- Moulded transparent connection piece allows permanent visual inspection
- Connection elements for phase cable:
 - Up to 70 mm² cross-section: 3x universal compact clamps
 - From 70 mm² cross-section: 3x universal phase clamps
- Connection elements for earth cable: M12 wing nut, M16 wing nut, earth clamp or earthing terminal
- Dimensions:
Distance between centre line of cable lug hole and entry of the connection piece:
Phase cable: 600 mm/550 mm/600 mm
Earth cable: 1,500 mm



Connection to: Fixed ball point Ø [mm]	T-connection bolt [mm]	Round conductor [mm]	Flat conductor [mm]	Cable cross section, phase/earth cable [mm ²]	Rated values I _r [kA]/tr=1 s	Order no. of kit			
						Wing nut M12	Wing nut M16	Earth clamp	Earthing terminal
20	15	4–15	0–25	50/50	9.9	60-0308-001	–	60-0301-001	60-0307-001
20	15	4–15	0–25	70/35	13.8	60-0308-003	–	60-0301-003	60-0307-003
20	15	4–15	0–25	70/70	13.8	60-0308-002	–	60-0301-002	60-0307-002
25	15	10–25	0–28	95/35	18.7	60-0508-002	–	60-0501-001	60-0507-002
25	15	10–25	0–28	95/95	18.7	60-0508-001	60-0509-001	60-0502-001	60-0507-001
25	15	10–25	0–28	120/50	23.7	60-0508-003	–	60-0501-002	60-0507-003
25	15	10–25	0–28	120/120	23.7	–	60-0509-002	60-0502-002	–

Earthing and short-circuiting devices with other cable lengths and fittings for line or earth cable ends are available on request (see on page 169).

Accessories	Page
Hot sticks	151
Earthing sticks	150
Wall holders	



Single-phase earthing and short-circuiting cable

Product features

- Designed according to IEC 61230 (VDE 0683-100)
- Cables assembled from highly flexible copper conductors (with transparent insulation)
- Cable lug on each cable end

Each cable lug is provided with a 13 mm diameter hole. Any type of line or phase clamp can be used for the earthing cables.

Cross section of copper conductor [mm ²]	Rated values I _r [kA]/tr = 1 s	Cable length [mm ²]	Order no.	Accessories	Page
25	4.9	800	61-0101-015	Line clamps	145
25	4.9	2,000	61-0101-003	Earth clamps	148
25	4.9	2,500	61-0101-016	Hot sticks	151
35	6.9	2,000	61-0102-003	Earthing sticks	150
35	6.9	3,000	61-0102-009	Wall holders	155
50	9.9	1,200	61-0103-001		
50	9.9	1,500	61-0103-002		
50	9.9	2,000	61-0103-003		
70	13.8	800	61-0104-018		
70	13.8	1,200	61-0104-001		
70	13.8	1,500	61-0104-002		
70	13.8	2,000	61-0104-003		
95	18.7	1,200	61-0105-001		
95	18.7	1,500	61-0105-002		
95	18.7	3,000	61-0105-009		
95	18.7	4,000	61-0105-008		
95	18.7	5,000	61-0105-010		
120	23.7	1,000	61-0106-012		
120	23.7	1,200	61-0106-001		
120	23.7	1,500	61-0106-002		
120	23.7	2,000	61-0106-003		
120	23.7	3,000	61-0106-006		
150	29.6	1,200	61-0107-001		
150	29.6	1,500	61-0107-002		
150	29.6	2,000	61-0107-003		
150	29.6	2,500	61-0107-009		
150	29.6	3,000	61-0107-006		

Earthing and short-circuiting devices with other cable lengths and fittings for line or earth cable ends are available on request (see on page 169).

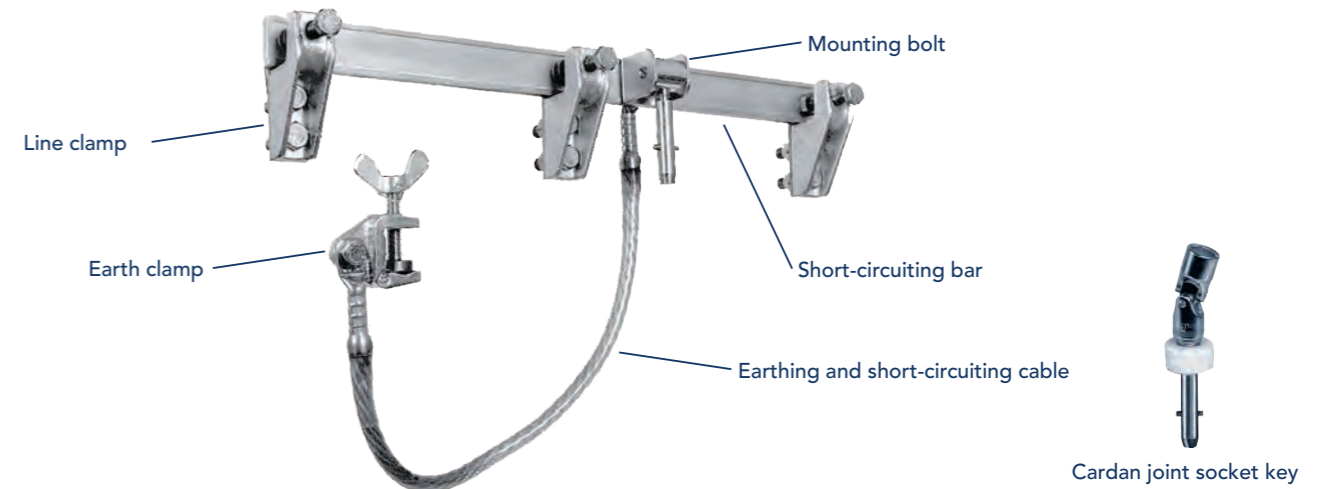

Short-circuiting bar with accessories

Equipment set	Rail length [mm]	Rated values I _r [kA]/tr = 1 s	Phase distance of line clamps [mm]	Order no.	Page
1 short-circuiting bar, with mounting bolt					
40 x 10	560	45.9	210	62-0101-050	
40 x 10	640	45.9	250	62-0101-051	
60 x 8	560	55.9	210	62-0101-054	
60 x 8	1,000	55.9	450	62-0101-057	
3 clamping pieces, for short-circuiting bar	Bolts	Material			
40 x 10	M12, AF19	GTW		62-0103-001	
60 x 8	M12, AF19	GK-ALSi 10 MG		62-0103-003	
1 earthing and short-circuiting cable					143
1 earth clamps					148

Accessories	Order no.	Page
Cardan joint socket key	67-0301-001	
Earthing sticks		150

Line connection points

Fixed ball points are suitable for phase connection points and busbars

Fixed ball point with female thread

Material of straight ball pin: E-Cu, tinned

Material of angle ball pin: CuCr, tinned



Ø [mm]	Thread	Rated values I _r [kA]/tr=1 s	Order no.
20	M10	18.7	63-0101-002
20	M12	18.7	63-0101-001
25	M12	23.7	63-0101-003
25	M16	29.6	63-0101-004



Ø [mm]	Thread	Rated values I _r [kA]/tr=1 s	Order no.
20	M12	13.8	63-0103-001
25	M12	23.7	63-0103-002
25	M16	29.6	63-0103-003

Ball point with steel grub screw

Material of straight ball pin: E-Cu, tinned

Material of angle ball pin: CuCr, tinned



Ø [mm]	Thread	Rated values I _r [kA]/tr=1 s	Order no.
20	M10 x 30	18.7	63-0102-002
20	M12 x 30	18.7	63-0102-001
25	M12 x 30	23.7	63-0102-003
25	M16 x 45	29.6	63-0102-004



Ø [mm]	Thread	Rated values I _r [kA]/tr=1 s	Order no.
20	M12 x 30	13.8	63-0104-001
25	M12 x 30	23.7	63-0104-002
25	M16 x 45	29.6	63-0104-003

T-connection bolts

Material: E-Cu, tinned



Ø [mm]	Thread	Rated values I _r [kA]/tr=1 s	Order no.
20	M12	13.8	63-0106-001
20	M12 x 30	13.8	63-0106-002

Line clamps

Line clamps with bayonet fitting

Material of universal compact clamp: CuCr, tinned

Material of universal line clamp: brass, tinned

Material of ball tongs: brass, zinc-plated



Ball pin Ø [mm]	Connection to				Rated values I _r [kA]/tr=1 s	Order no.			Ball tong
	T-connection bolt [mm]	Round conductor [mm]	Flat conductor [mm]			Universal compact clamp	Universal phase clamp	Universal phase clamp	
20	-	-	-	-	18.7	-	-	-	64-0103-001
25	-	-	-	-	29.7	-	-	-	64-0103-002
20	15	4-15	≤25	≤22	13.8	64-0101-001	-	-	-
20	-	10-20	≤22	-	13.8	-	64-0102-001	-	-
25	15	10-25	≤28	-	23.7 ¹⁾	-	64-0102-002	-	-
20/25	15	10-25	≤28	-	18.7/23.7 ¹⁾	-	-	64-0102-003	-
25/30	15	10-30	≤28	-	23.7/29.6 ¹⁾	-	-	64-0102-004	-

1) The rated value for the T-connection bolt is always 13.8 kA.

Line clamps with hexagon spindle

Material: brass, zinc-plated



Connection to: ball pin Ø [mm]	Rated values I _r [kA]/tr=1 s	Order no.
20	18.7	64-0103-005
25	29.7	64-0103-006

Earth connection points

Earth connection bolts with ring groove for earthing terminal

Material: brass, tinned



Welding type

Fixing in switchgears [mm]	Rated values Ir [kA]/tr = 1 s	Order no.
-	18.7	63-0201-001



With steel pin

Fixing in switchgears [mm]	Rated values Ir [kA]/tr = 1 s	Order no.
M12 x 25	18.7	63-0201-007
M12 x 40	18.7	63-0201-006



With female thread

Fixing in switchgears [mm]	Rated values Ir [kA]/tr = 1 s	Order no.
M12	18.7	63-0201-003

Earthing weld nut for cable lug with captive wing nut or with 13 mm diameter hole

Material: steel, zinc-plated



Connection point for earthing device [mm ²]	Rated values Ir [kA]/tr = 1 s	Order no.
M12 x 30	18.7	63-0204-001

Earthing screw for cable lug with captive wing nut

Material: brass, zinc-plated



Fixing point for earthing device [mm ²]	Spanner size	Rated values Ir [kA]/tr = 1 s	Order no.
M12 x 60	32	13.8	63-0205-001
M16 x 70	32	18.7	63-0205-002

Earthing screw adapter fo cable lug with captive wing nut

Material: brass, zinc-plated



Thread [mm ²]	Spanner size	Rated values Ir [kA]/tr = 1 s	Order no.
M12 to 16	32	9.9	63-0205-003

Earthing nut for cable lug with captive wing bolt

Material: brass, zinc-plated



Female thread [mm ²]	Bolt thread [mm ²]	Spanner size	Rated values Ir [kA]/tr = 1 s	Order no.
M12	M12	32	9.9	63-0206-001
M12	M16 x 30	32	9.9	63-0206-003
M16	M12 x 25	32	9.9	63-0206-002

Earth clamps

Earth clamp

Material: CuNi, zinc-plated



With T-handle

Clamping range [mm]	Rated values Ir [kA]/tr=1 s	Order no.
23	18.7	64-0201-001
38	29.6	64-0201-002



With wing bolt

Clamping range [mm]	Rated values Ir [kA]/tr=1 s	Order no.
23	18.7	64-0201-003
38	29.6	64-0201-004



With bayonet connector

Clamping range [mm]	Rated values Ir [kA]/tr=1 s	Order no.
23	18.7	64-0201-005
38	29.6	64-0201-006

Universal earth clamp with handle

Material: brass, tinned



Connection to:				Rated values Ir [kA]/tr=1 s	Order no.
Fixed ball point Ø [mm]	Round conductor [mm]	T-connection bolt[mm]	Flat conductor [mm]		
25	10–25	0–28	≤28	23.7 ¹⁾	64-0102-007
20/25	10–25	0–28	≤28	18.7/23.7 ¹⁾	64-0102-009

1) The rated value for the T-connection bolt is always 13.8 kA.

Earthing terminal

Material: brass, zinc-plated/E-Cu



Cable cross section [mm]	Rated values Ir [kA]/tr=1 s	Order no.
50	9.9	64-0202-003
70	13.8	64-0202-004
95	18.7	64-0202-005

Earth connecting elements

Cable lug with captive wing nut

Material: E-Cu, tinned



Cable cross section [mm ²]	Thread	Rated values Ir [kA]/tr=1 s	Order no.
50	M12	9.9	64-0203-001
70	M12	13.8	64-0203-002
95	M12	18.7	64-0203-003

Cable lug with captive wing bolt

Material: E-Cu, tinned



Cable cross section [mm ²]	Thread	Rated values Ir [kA]/tr=1 s	Order no.
50	M12 x 15	9.9	64-0204-001
70	M12	13.8	64-0204-002
95	M12	18.7	64-0204-003

Cable lug with 13 mm Ø hole

Material: E-Cu, tinned



Cable cross section [mm ²]	Rated values Ir [kA]/tr=1 s	Order no.
50	9.9	64-0205-003
70	13.8	64-0205-004
95	18.7	64-0205-005

Earthing sticks

For installation and removal of earthing and short-circuiting devices in high-voltage installations

Product features

- Designed according to VDE 0683-100 (IEC 61230)
- Material: fibreglass reinforced epoxy resin tube
- Types: bayonet or hexagonal fitting
- Application for indoor 🏠 installations

The insulating element of the earthing stick must be of adequate dimension to avoid inadmissible high leakage currents. The minimum length of the insulating element is 500 mm.

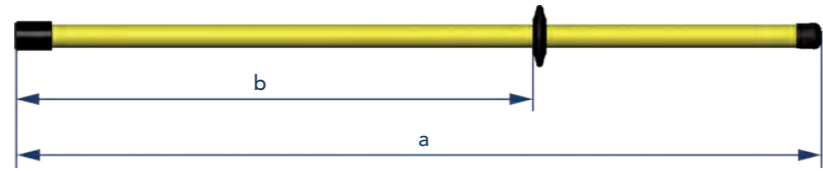

Indoor application earthing stick

Dimensions [mm]	Order no.	
	Bayonet fitting	Hexagon fitting
a ¹⁾	b	
1,117	717	66-0101-001 66-0201-001
1,517	917	66-0101-002 66-0201-002
2,017	1.217	66-0101-003 66-0201-003

1) Dimensions apply to earthing sticks with bayonet fitting. Earthing sticks with hexagonal fitting are 12 mm longer.

Hot sticks

Manual operation of live parts

Product features

- Designed according to DIN VDE 0681-1
- Material: fibreglass reinforced epoxy resin tube
- Types: bayonet or hexagonal fitting
- Application for indoor 🏠 or outdoor 🏠🌧️ installation

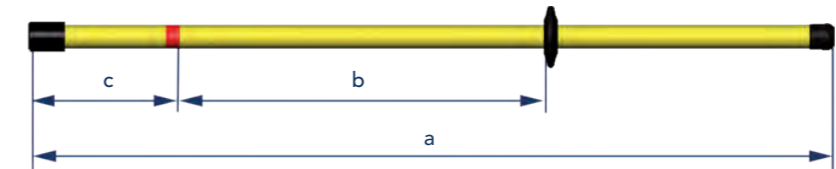

Indoor application hot stick

Nominal voltage max. [kV]	Dimensions [mm]			Order no.	
	a ¹⁾	b	c ¹⁾	Bayonet fitting	Hexagon fitting
20	1,100	500	217	65-0101-001	65-0201-001
30	1,200	525	242	65-0101-002	65-0201-002
45	1,500	720	197	65-0101-003	65-0201-003
60	2,000	905	312	65-0101-004	65-0201-004

1) Dimensions apply to hot sticks with bayonet fitting. Hot sticks with hexagonal fitting are 12 mm longer.

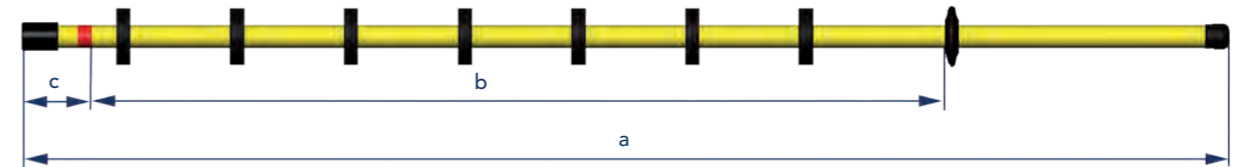

Outdoor application hot stick

Nominal voltage max. [kV]	Dimensions [mm]			Order no. Bayonet fitting
	a	b	c	
30	1,707	1,200	107	65-0102-001
60	2,317	1,600	117	65-0102-002

With hook for applications in dry weather conditions 🏠

The hook serves to mount and dismount elbow connectors and for overhead faulted circuit indicator installations and removals.

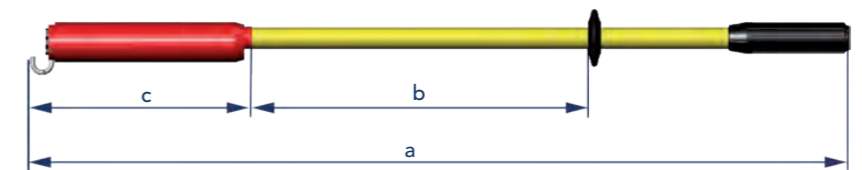

Hot stick with hook

Nominal voltage max. [kV]	Dimensions [mm]			Order no.
	a	b	c	
20	1,200	500	310	65-0301-001
30	2,000	900	310	65-0301-002
30	3,000	900	1,310	65-0301-003
46	2,000	900	310	65-0301-004

Operating rods

Used to switch on and off switches with ring eyes

Product features

- Designed according to VDE 0681-2 (DIN 57681-2)
- Material: fibreglass reinforced epoxy resin tube
- One-part and two-part pluggable design
- Application for indoor 🏠 or outdoor installation 🏡

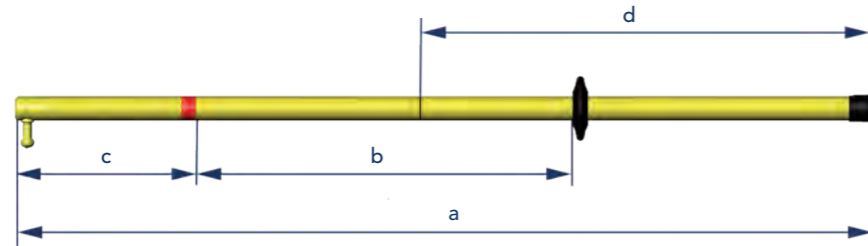

Indoor application operating rod

Nominal voltage max. [kV]	Dimensions [mm]				Order no.	
	a	b	c	d ¹⁾	One-part	Two-part
20	1,120	505	215	600	65-0401-001	65-0403-001
30	1,220	525	245	–	65-0401-002	–
45	1,520	720	200	800	65-0401-003	65-0403-003
60	2,020	900	320	1,050	65-0401-004	65-0403-004

1) Dimensions only for two-part operating rods.

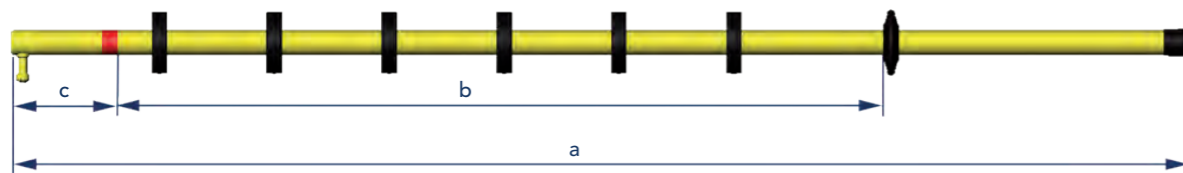

Outdoor application operating rod

Nominal voltage max. [kV]	Dimensions [mm]			Order no.
	a	b	c	
20	1,520	1,000	120	65-0402-001
30	1,720	1,200	120	65-0402-002
45	2,180	1,400	180	65-0402-003
60	2,320	1,600	120	65-0402-004

Switch hook with bayonet fitting

Suitable for all operating rods (bayonet fitting according to DIN 48087)



Order no.
67-0301-003

Fuse tongs

For gripping and replacing high-voltage HH fuses

Product features

- According to VDE 0681-3 (DIN 57681-3)

The fuse tongs are guided over the fuses from the front, thus requiring little spaces to the side. They are ideally suited for use in narrow installations. The clamps are fixed and released by turning the handle.

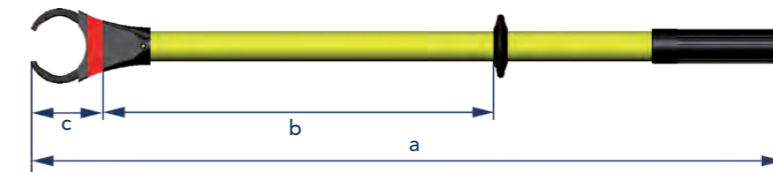

Fuse tong type K

Nominal voltage max. [kV]	Dimensions [mm]			Clamping range [mm]	Order no.
	a	b	c ¹⁾		
1–30 kV	1,010	530	85	50–90	65-0502-002

1) In closed position.

Tools for fuses

Material: Special brass

Total length [mm]	Order no.
385	65-0504-001

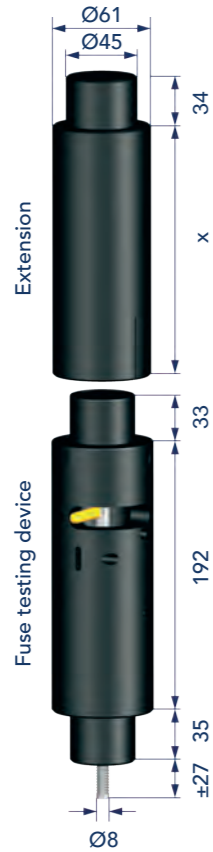

Fuse testing device and extension

The mechanical HPS fuse testing device is designed to control the trip function of load break switches.

The testing fuse consists of a cylindrical fuse body similar to that of HH fuses and is fitted with a mechanical release device, timer and striker pin.

After winding up the timer the striker pin is reset and the testing device is inserted into the fuse cartridge of the switch to be checked.

After about 150 s ±20 % the test fuse is operated whereupon the striker fires out. The size of the fuse corresponds to that of HH fuses with 6 kV nominal voltage. Extension pieces are available for the adaptation to other voltage levels.

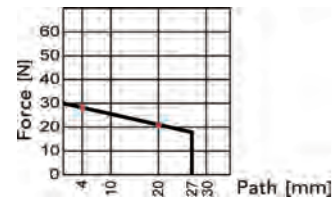

Rated release force 30 N

Free stroke
4 mm [N] 28.2
20 mm [N] 20.8
Energy [J] 0.39

Order no.
49-6015-007 (white)

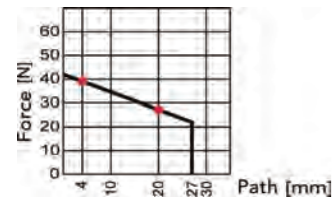

Rated release force 42 N

Free stroke
4 mm [N] 39.0
20 mm [N] 27.2
Energy [J] 0.53

Order no.
49-6015-001 (black)

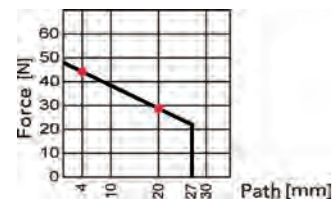

Rated release force 48 N

Free stroke
4 mm [N] 44.1
20 mm [N] 28.7
Energy [J] 0.58

Order no.
49-6015-006 (blanc)

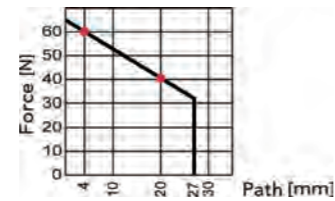

Rated release force 65 N

Free stroke
4 mm [N] 60.1
20 mm [N] 40.6
Energy [J] 0.81

Order no.
49-6015-005 (yellow)

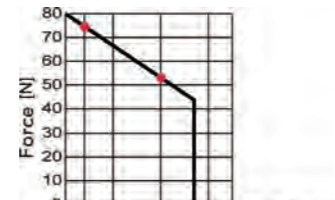

Rated release force 80 N

Free stroke
4 mm [N] 74.7
20 mm [N] 53.3
Energy [J] 1.02

Order no.
49-6015-008 (silver)

Accessories	Un [kV]	Order no.
Extension		
100 mm	12.0	49-6015-003
175 mm	17.5	49-6015-004
250 mm	24.0	49-6015-002
Bag		52-0102-003

For safety material



Order no.	67-0101-001	67-0101-002	67-0101-006	67-0101-007	67-0101-014	67-0101-015
Earthing and short-circuiting devices	■	-	-	-	-	-
Earthing sticks	-	-	■	-	-	-
Hot sticks	-	■	■	-	-	-
Operating rods	-	■	-	-	-	-
Fuse tongs	-	■	■	■	■	-
HH fuses	-	-	-	-	■	■

For voltage detectors



Order no.	52-0105-001	52-0105-002
FL-I	■	■
TP-I	■	■
Comet BK-I/BK-A	■	■
Comet BL-I/BL-A	■	■
Comet BS-I/BS-A	■	■

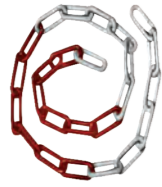

Plastic chain
Red/white with nylon links
Order no. 67-0202-001



Safety helmet
Without face shield
Order no. 67-0202-002
With face shield
Order no. 67-0202-003



High-grade protective helmet
Without face shield
Order no. 67-0202-012
With face shield
Order no. 67-0202-013

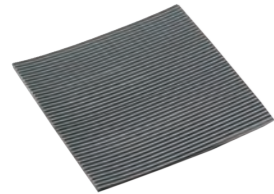

Rubber insulating matting
Up to 50 kV, max. 1 m wide, 4 mm thick, 10 m long (delivered as a roll)
Order no. 67-0202-004



Protective gloves
For electricians, 1,000 V according to VDE 0680-1 with certification stamp, length: 350 mm, thickness: 0.7 mm
Order no. 67-0202-005



Handheld fire extinguisher
Filled with 5 kg of carbon dioxide, with snow pipe and wall holder
Order no. 67-0202-007



LED work lamp
Incl. wall-mounting charge station with charge status display, flashing and emergency light function
Order no. 67-0202-010

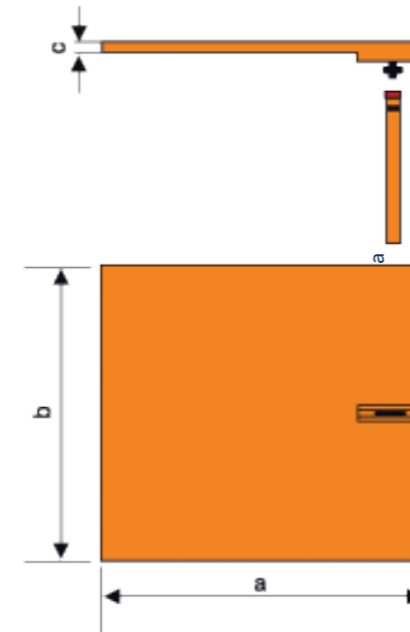
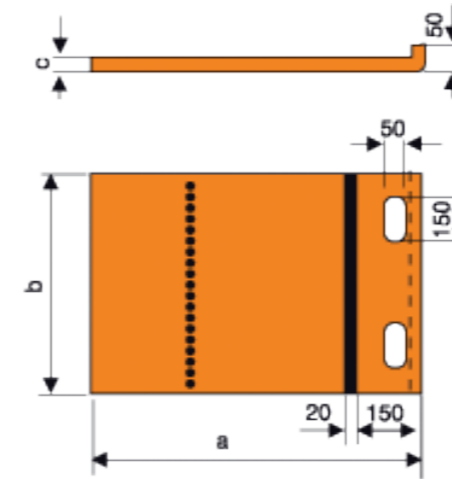

Dimensions insulating protective barriers

Product features

- According to VDE 0682-552
- Provides partial protection against direct contact

Insulating protective barriers are intended for short-term use in electrical indoor switchgears exceeding voltage ratings from 1 kV bis 30 kV AC.

These devices may be used in factory-built, type-tested switchgears only in compliance with the switchgear manufacturer's instructions.

Insulating protective barriers are designed for partial protection against direct touching. These components do not protect against reclosure and must not touch live parts when installed.

According to requirement and application, numerous types of insulating protective barriers are necessary. They are installed manually by hand or using an insulating or operating stick.

Appropriate holders or guide rails shall be provided.

Depending on the size and type of barrier, reinforcements in the form of U-sections are installed at the bottom of the barrier to prevent the component from being bent.

Technical data	Insulating protective barrier
Material	PVC hard DIN 16927
Colour	red, similar RAL 3000
Plate thickness	<30 kV, 6 mm
Special insulation resistance	10 ¹⁵ Ω cm
Surface resistivity	10 ¹¹ Ω

Equipment set	Page	Accessories	Page
Insulating protective barrier	Order no. on request	Hot stick	151

The products marked with * are available in the ePLAN-data Portal with the circuit diagram and terminal assignment.

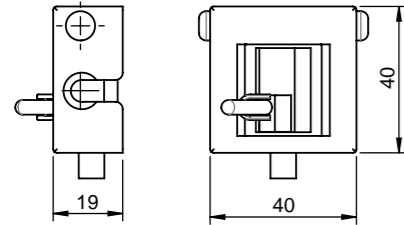

M1: Rotor indicator

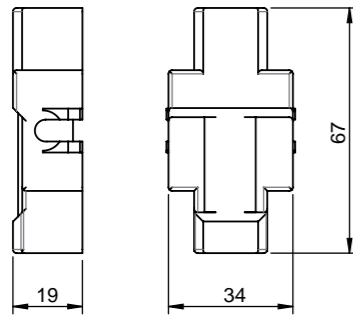

M2: Fluid indicator

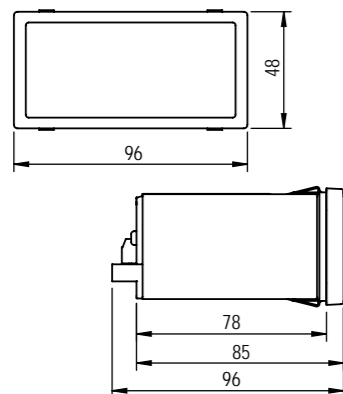

M3: Alpha E, ComPass A, ComPass B*, ComPass BN, Opto series, Sigma* series

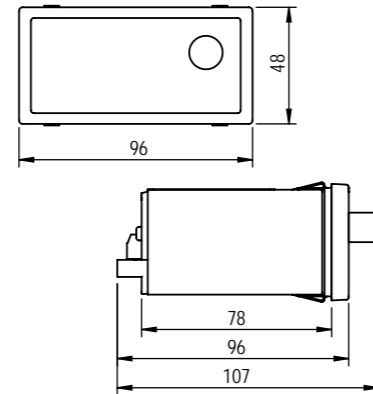

M4: Alpha M, Trip Flag

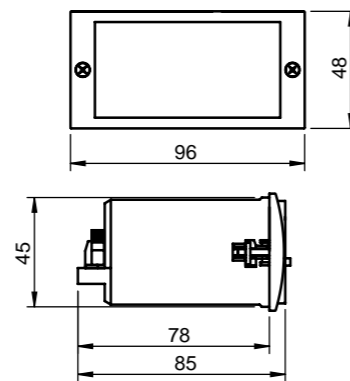

M5: Earth (plug-in housing)

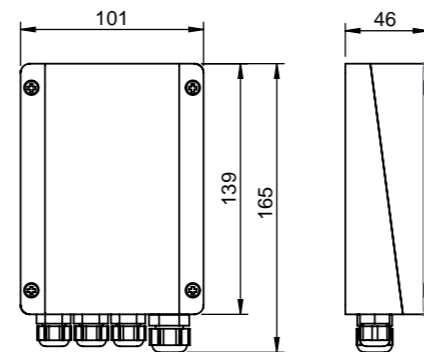

M6: Earth, Opto, Sigma plus (surface mount housing)

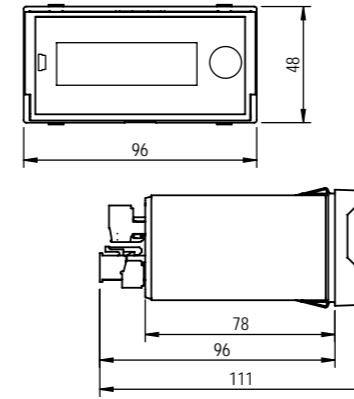

M7: ComPass A 2.0*/ComPass B/Bs 2.0*

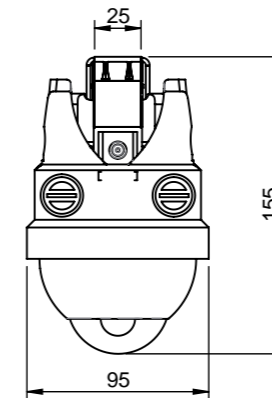

M8: Navigator series, Smart Navigator series

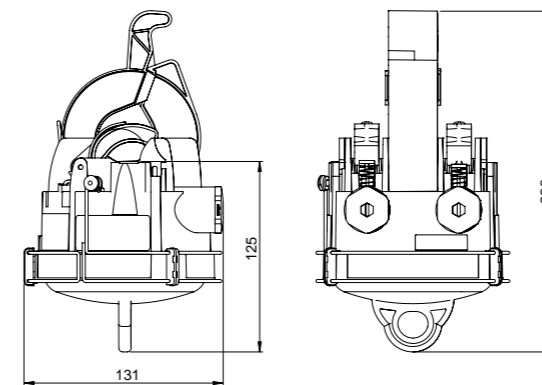

M9: Smart Navigator 2.0

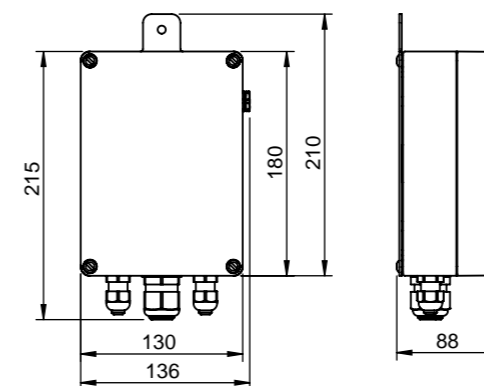

M10: Reporter 3.0

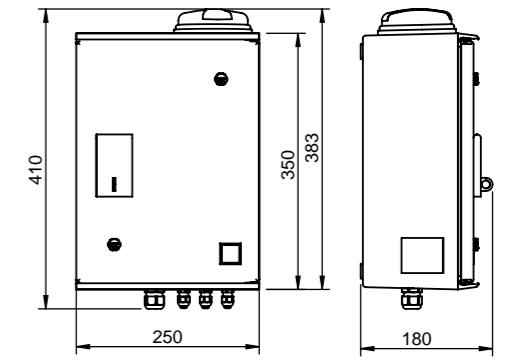

M11: Reporter 4.0

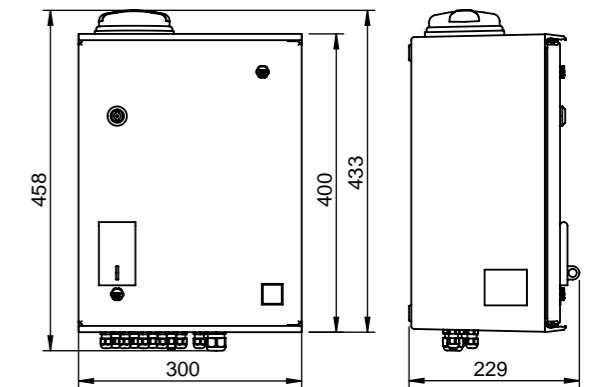

M12: ComPass AX12

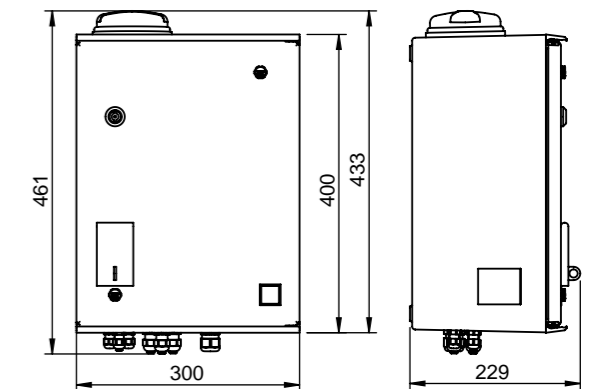

M13: ComPass BX12

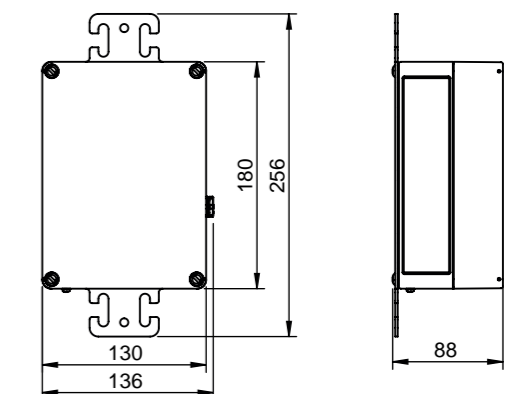

M14: Radio Reporter 2.0

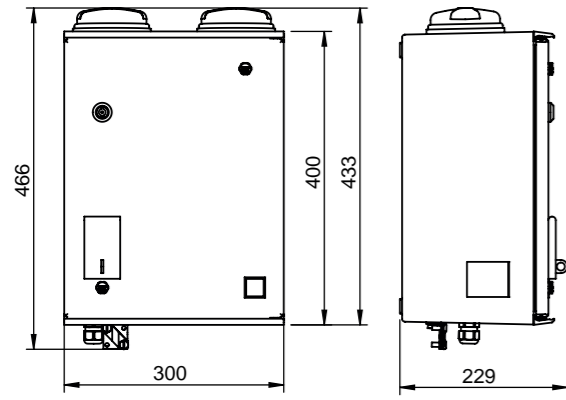

M15: Smart Reporter

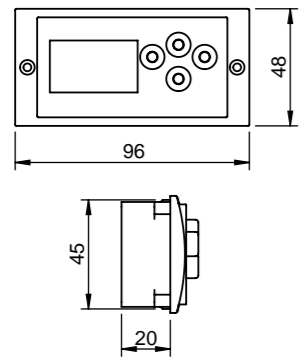

M16: Wega 1.2 C*

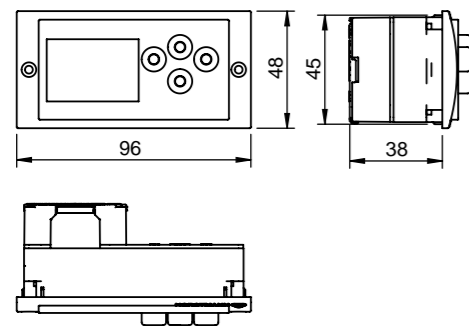

M17: Wega 1.2 C vario*, Wega T1 vario

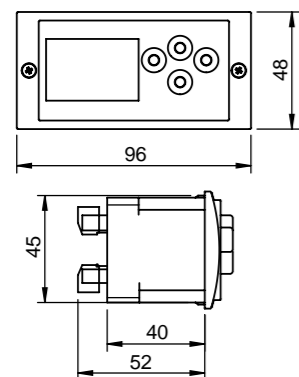

M18: Wega 2.2 C*

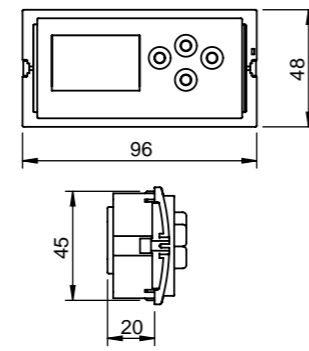

M19: Wega 3, Wega LRM

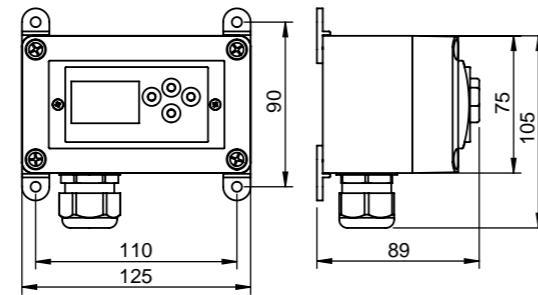

M20: Wega T1

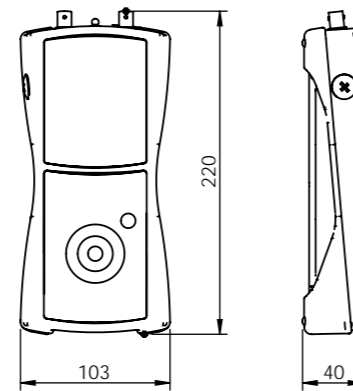

M21: Orion 3.1, Orion M1

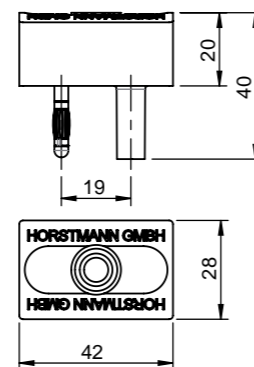

M22: HR-ST

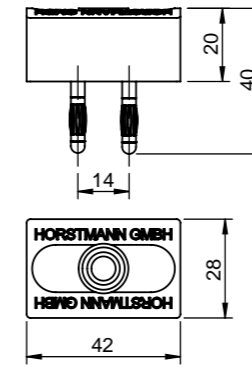

M23: LRM-ST

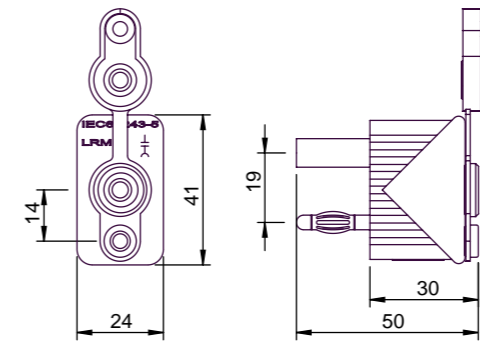

M24: Interface adapter converter

Weights

Order no.	Total [kg]	Cu [kg]	MS63 [kg]
20-0101-001	0.14	-	-
20-0102-001	0.16	-	-
20-0103-001	0.19	-	-
20-0104-001	0.24	-	-
20-0105-001	0.27	-	-
20-0106-001	0.28	-	-
20-0108-001	0.39	-	-
20-0120-001	0.16	-	-
20-0121-001	0.26	-	-
20-0122-001	0.15	-	-
20-0123-001	0.17	-	-
20-0401-000	0.12	-	-
20-0402-000	0.17	-	-
20-0403-000	0.20	-	-
20-0404-000	0.23	-	-
20-0405-000	0.27	-	-
20-0406-000	0.30	-	-
20-0408-000	0.40	-	-
20-0410-000	0.23	-	-
20-0420-000	0.17	-	-
20-0421-000	0.25	-	-
20-0422-000	0.15	-	-
20-0423-000	0.16	-	-
28-3130-001	0.60	-	-
28-3131-001	0.60	-	-
28-5000-001	0.01	-	-
28-7101-022	0.40	-	-
28-7330-022	0.40	-	-
28-7502-020	9.90	-	-
28-7502-021	9.50	-	-
28-7502-053	6.79	-	-
28-7502-055	6.79	-	-
30-1715-001	0.17	-	-
30-1815-001	0.22	-	-
32-0502-002	0.26	-	-
32-0503-001	0.26	-	-
32-0504-115	0.30	-	-
32-0512-002	0.13	-	-
32-0513-001	0.13	-	-
33-0513-001	0.21	-	-
33-0613-001	0.32	-	-
36-0313-001	0.32	-	-
36-0323-001	0.18	-	-
37-1111-101	0.17	-	-
37-1121-101	0.17	-	-
37-2111-101	0.17	-	-
37-2121-101	0.17	-	-
37-3110-001	0.20	-	-
37-3120-001	0.25	-	-
37-3510-001	0.33	-	-
37-3520-001	0.20	-	-
37-5113-101	0.17	-	-

Order no.	Total [kg]	Cu [kg]	MS63 [kg]
37-5123-101	0.10	-	-
37-6000-001	0.26	-	-
37-6100-001	0.25	-	-
37-6200-001	0.24	-	-
38-0102-001	0.25	-	-
38-0152-001	0.27	-	-
38-4102-001	0.24	-	-
38-4110-001	0.20	-	-
38-4150-001	0.31	-	-
38-4153-001	0.30	-	-
38-9100-013	3.10	-	-
38-9100-017	3.51	-	-
38-9100-026	7.56	-	-
38-9100-050	3.10	-	-
38-9100-060	2.14	-	-
48-0101-002	1.13	-	-
48-0101-003	2.12	-	-
48-0101-004	2.63	-	-
49-0101-202	0.12	-	-
49-0101-203	0.14	-	-
49-0101-206	0.10	-	-
49-0109-002	0.08	-	-
49-0109-003	0.01	-	-
49-0509-007	0.03	-	-
49-0509-008	0.03	-	-
49-0509-012	0.20	-	-
49-0509-013	0.20	-	-
49-0509-014	0.20	-	-
49-0509-015	0.20	-	-
49-0509-024	0.10	-	-
49-0509-024	0.10	-	-
49-0509-031	0.21	-	-
49-0509-034	0.20	-	-
49-0509-036	0.20	-	-
49-0509-039	0.20	-	-
49-0509-061	0.20	-	-
49-0509-062	0.20	-	-
49-0509-180	0.02	-	-
49-0509-188	0.14	-	-
49-0509-190	0.02	-	-
49-0509-245	0.20	-	-
49-0509-246	0.32	-	-
49-0509-311	0.06	-	-
49-0511-002	0.10	-	-
49-0602-001	0.02	-	-
49-0602-009	0.02	-	-
49-0702-005	0.28	-	-
49-0702-010	0.51	-	-
49-0702-015	0.56	-	-
49-0704-001	0.22	-	-
49-0706-001	0.24	-	-
49-0921-002	0.22	-	-

Order no.	Total [kg]	Cu [kg]	MS63 [kg]
49-6001-002	0.37	-	-
49-6001-010	0.03	-	-
49-6003-201	0.12	-	-
49-6003-210	0.22	-	-
49-6003-212	0.36	-	-
49-6003-213	0.18	-	-
49-6003-215	0.28	-	-
49-6003-330	0.56	-	-
49-6006-004	0.31	-	-
49-6007-206	0.02	-	-
49-6010-011	0.16	-	-
49-6010-030	0.12	-	-
49-6010-032	0.35	-	-
49-6010-044	0.15	-	-
49-6010-048	0.14	-	-
49-6010-052	0.12	-	-
49-6010-060	0.16	-	-
49-6011-040	0.27	-	-
49-6011-043	0.46	-	-
49-6012-005	0.21	-	-
49-6012-007	0.31	-	-
49-6012-009	0.27	-	-
49-6012-015	0.62	-	-
49-6013-016	0.60	-	-
49-6013-027	1.15	-	-
49-6013-028	1.05	-	-
49-6013-029	0.33	-	-
49-6014-007	0.75	-	-
49-6014-009	0.73	-	-
49-6014-021	1.07	-	-
49-6014-022	0.94	-	-
49-6015-001	1.50	-	-
49-6015-002	0.75	-	-
49-6015-003	0.28	-	-
49-6015-004	0.52	-	-
49-6015-005	1.50	-	-
49-6015-006	1.50	-	-
49-6015-007	1.50	-	-
49-6015-008	1.50	-	-
49-6021-001	0.14	-	-
49-6022-010	0.46	-	-
49-6022-030	2.00	-	-
49-6023-020	1.08	-	-
49-6024-001	0.36	-	-
49-6024-010	0.83	-	-
49-6025-000	0.33	-	-
49-6025-301	0.27	-	-
49-6025-311	0.30	-	-
49-6025-601	0.27	-	-
49-6025-611	0.30	-	-
49-6025-622	1.06	-	-
49-6025-630	0.74	-	-
49-9001-001	0.33	-	-
49-9001-002	0.25	-	-
49-9001-006	0.26	-	-
49-9010-001	0.22	-	-
50-0901-011	0.80	-	-
50-0901-012	0.81	-	-

Order no.	Total [kg]	Cu [kg]	MS63 [kg]
50-0901-013	0.84	-	-
50-0901-014	0.84	-	-
50-0901-015	0.87	-	-
50-0901-022	0.90	-	-
50-0903-008	0.81	-	-
50-0903-009	0.80	-	-
50-0903-010	0.83	-	-
50-0903-011	0.85	-	-
50-0903-012	0.89	-	-
50-0903-018	0.88	-	-
50-0921-001	0.89	-	-
50-0923-001	0.90	-	-
50-1001-009	0.90	-	-
50-1001-010	0.90	-	-
50-1001-011	1.00	-	-
50-1001-012	0.98	-	-
50-1001-013	1.05	-	-
50-1001-015	1.06	-	-
50-1003-009	0.90	-	-
50-1003-010	0.90	-	-
50-1003-011	1.00	-	-
50-1003-012	0.99	-	-
50-1003-013	1.05	-	-
50-1003-018	1.07	-	-
50-1021-001	1.05	-	-
50-1023-001	1.05	-	-
50-1201-001	0.80	-	-
50-1201-002	0.80	-	-
50-1201-003	0.82	-	-
50-1301-001	0.70	-	-
50-1301-002	0.71	-	-
50-1303-001	0.75	-	-
50-1303-002	0.77	-	-
50-1401-001	0.80	-	-
50-1401-002	0.77	-	-
50-1403-001	0.80	-	-
50-1403-002	0.87	-	-
50-1510-001	3.06	-	-
50-1510-002	3.06	-	-
50-1511-001	3.00	-	-
50-1511-002	3.00	-	-
50-1511-003	3.00	-	-
51-0102-001	1.60	-	-
51-0102-002	1.60	-	-
51-0102-003	1.60	-	-
51-0102-004	1.66	-	-
51-0102-005	1.60	-	-
51-0102-011	1.64	-	-
51-0104-001	1.02	-	-
51-0201-003	0.86	-	-
51-0201-004	0.93	-	-
51-0201-005	0.92	-	-
51-0201-007	0.94	-	-
51-0205-010	0.03	-	-
51-0205-011	0.03	-	-
51-0206-101	1.07	-	-
51-0206-102	0.91	-	-
51-0206-201	1.40	-	-

Order no.	Total [kg]	Cu [kg]	MS63 [kg]
67-0201-003	0.01	-	-
67-0201-004	0.20	-	-
67-0201-005	0.90	-	-
67-0201-006	0.50	-	-
67-0201-007	0.01	-	-
67-0201-009	0.03	-	-
67-0201-010	2.12	-	-
67-0301-003	0.20	-	-
99-0000-124	0.10	-	-
V28-7502-052-001	12.30	-	-
V49-9001-004-001	0.67	-	-
V49-9001-007-001	0.82	-	-
V51-1250-101-001	0.15	-	-
V51-1250-120-004	0.15	-	-
V51-1250-121-001	0.15	-	-
V51-1250-129-001	0.15	-	-
V51-1250-131-001	0.15	-	-
V51-1250-133-001	0.15	-	-
V51-1251-001-301	0.76	-	-
V51-1251-001-302	0.76	-	-
V51-1251-001-303	0.76	-	-
V51-1251-001-310	0.76	-	-
V51-1300-001-001	0.16	-	-
V51-1300-001-002	0.19	-	-
V51-1300-001-004	0.17	-	-
V51-1300-001-121	0.15	-	-
V51-1300-001-151	0.15	-	-
V51-1300-001-155	0.15	-	-
V51-1300-001-161	0.15	-	-
V51-1300-001-201	0.17	-	-
V51-1300-001-202	0.17	-	-
V51-1300-001-301	0.17	-	-
V51-1300-001-302	0.14	-	-
V51-1410-001-101	0.12	-	-
V51-1410-001-102	0.12	-	-
V51-1410-001-103	0.12	-	-
V51-1410-001-104	0.12	-	-
V51-1410-001-105	0.12	-	-
V51-1410-001-106	0.12	-	-
V51-1410-001-107	0.12	-	-
V51-1410-001-108	0.12	-	-
V51-1410-001-109	0.12	-	-
V51-1410-001-110	0.12	-	-
V51-1421-001-101	0.14	-	-
V51-1421-001-102	0.14	-	-
V51-1421-001-103	0.14	-	-
V51-1421-001-104	0.14	-	-
V51-1421-001-105	0.14	-	-
V51-2250-106-001	0.27	-	-
V51-2250-115-001	0.27	-	-
V51-2250-119-001	0.27	-	-
V51-2250-120-004	0.27	-	-
V51-2250-134-001	0,27	-	-
V99-0000-124-001	0,10	-	-

Order no.:		Inquiry no.:	
------------	--	--------------	--

Order no.	Article description	Quantity	Delivery date

Lengths of earthing and short-circuit cables have to fit to the switchgear and the distances between the connection points (min 1.2 times of the distance). If the cables are too long (>1.5 times of the distance) they must be fixed with an insulating cable to prevent damages and injuries in case of a short-circuit.

	Company:	
	Contact person:	
	Department:	
	Street:	
	Postcode / Place:	
Stamp / Date / Signature	Phone / Fax:	

An order is made exclusively by the terms and conditions of Dipl.-Ing. H. Horstmann GmbH.

Order no.		Inquiry no.	
Short-circuiting cable (a/b/c)			
Cable cross section (mm ²):			
Length a:			
Length b:			
Length c:			
Mounting:			
Earthing cable (d)			
Cable cross section (mm ²):			
Length d:			
Mounting:			
Quantity:			
Date of delivery:			

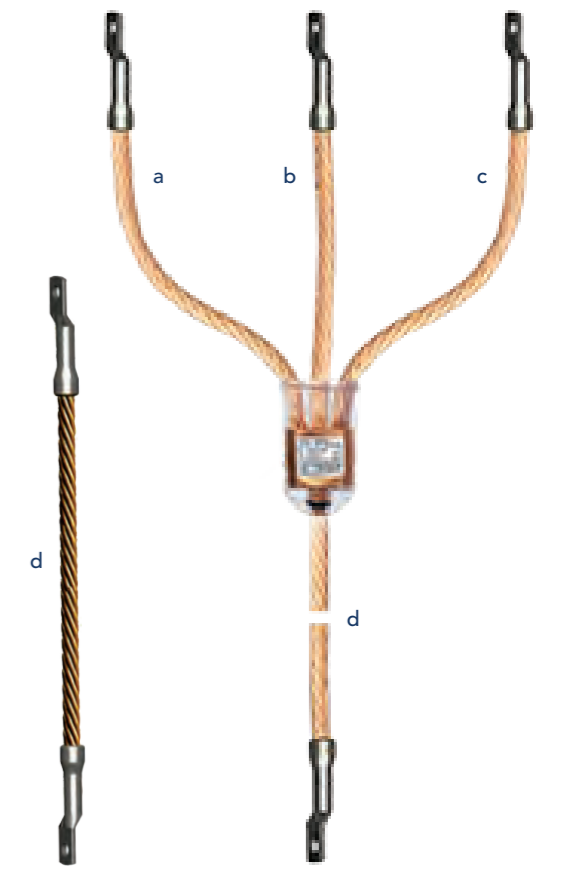

Lengths of earthing and short-circuit cables have to fit to the switchgear and the distances between the connection points (min 1.2 times of the distance). If the cables are too long (>1.5 times of the distance) they must be fixed with an insulating cable to prevent damages and injuries in case of a short-circuit.

	Company:	
	Contact person:	
	Department:	
	Street:	
	Postcode / Place:	
Stamp / Date / Signature	Phone / Fax:	

An order is made exclusively by the terms and conditions of Dipl.-Ing. H. Horstmann GmbH.

A

- Accessories
 - Directional fault indicators 56, 57
 - For substations 156
 - Integrated voltage detecting systems 56
 - Overhead faulted circuit indicators 76
 - Short-circuit and earth fault indicators 56, 57
 - Short-circuit indicators 56, 57
 - Voltage detectors and phase comparators 136
- Alpha E 12, 14, 26, 48, 49, 158
- Alpha M 12, 14, 26, 48, 49, 158

B

- BL-M 134, 135, 136, 137
- BO-A 2.0 128, 129

C

- Capacitive voltage signal 52, 54, 100
- Comet BK-A 118, 124, 125, 136, 137, 155
- Comet BK-I 118, 124, 125, 136, 137, 155
- Comet BL-A 118, 122, 123, 136, 137, 155
- Comet BL-I 118, 122, 123, 136, 137, 155
- Comet BS-A 118, 126, 127, 136, 137, 155
- Comet BS-I 118, 126, 127, 136, 137, 155
- Company profile 9
- Compare 2.0 119, 130, 131, 136, 137
- ComPass A 12, 17, 36, 37, 50, 56, 57, 158
- ComPass A 2.0 12, 17, 38, 39, 50, 56, 57, 159
- ComPass AX12 78, 83, 85, 90, 91, 159
- ComPass B 13, 19, 40, 41, 44, 45, 50, 51, 52, 56, 57, 88, 93, 158
- ComPass B 2.0 13, 19, 40, 41, 46, 47, 50, 52, 54, 55, 56, 57, 88, 159
- ComPass BN 50, 56, 57, 58, 59, 158
- ComPass BS 2.0 13, 19, 40, 41, 46, 47, 50, 52, 54, 55, 56, 57, 88, 159
- ComPass BX12 79, 83, 85, 92, 93, 159

D

- Dimension drawings 158
- Directional fault indicators
 - Accessories 56
 - Equipment set options 40
 - General information 10
 - Product matrix 18, 19
 - Project planning 41
 - Selection scheme 12
 - Single-phase current sensors 50
 - Voltage signal 52

E

- Earth 4.0 12, 15, 27, 51, 56, 158
- Earth clamps
 - Earth clamp 148
 - Earthing terminal 148
 - Universal earth clamp with handle 148
- Earth connecting elements
 - Cable lug with 13 mm Ø hole 149
 - Cable lug with captive wing bolt 149
 - Cable lug with captive wing nut 149

Earth connection points

- Earth connection bolts 146
- Earthing nut 147
- Earthing screw 147
- Earthing screw adapter 147
- Earthing weld nut 146

Earth fault indicators

- Accessories 56
- Product matrix 15
- Selection scheme 12

Earthing and short-circuiting devices

- Single-phase device without connection elements 142
- Three-phase device with ball tongs 140
- Three-phase device with universal line clamp 141

Earthing devices and accessories

- Accessories 155, 156
- General information 138

Earthing sticks 140, 141, 142, 143, 150, 155

- Earth Zero 12, 15, 28, 29, 51, 56, 57, 158
- Earth Zero Flag 12, 15, 28, 29, 51, 56, 57, 158
- Equipment set options 40

F

- FL-I 118, 120, 136, 137, 155
- Fluid indicator 12, 14, 21, 158
- Function tester HR/LRM-ST 116
- Fuse testing devices 154
- Fuse tongs 153, 155

G

- General information
 - Earthing devices and accessories 138
 - Remote monitoring 77
 - Short-circuit and earth fault indicators 10
 - Voltage detectors and voltage detecting systems 99

H

- Hot sticks 76, 140, 141, 142, 151, 155
- HR interface cable 40, 41, 52, 110
- HR-ST 116, 137, 160

I

- iHost 75, 77, 78, 81, 82, 83, 84, 85, 86, 87, 88, 89, 90, 91, 92, 93, 94, 95
- Installation system 43, 45, 47, 57
- Insulating protective barrier 157
- Integrated voltage detecting systems (VDS) 100
- Interface adapter converter 117, 161
- Interface cable 40, 41, 110, 111

L

- Line clamps
 - Line clamps with bayonet fitting 145
 - Line clamps with hexagon spindle 145
- Line connection points
 - Ball point with steel grub screw 144
 - Fixed ball point with female thread 144
 - T-connection bolts 144
- LRM-ST 116, 137, 161

M

- Maintenance test 137

N

- Navigator LED + Flag 62, 66, 67, 76, 159
- Navigator LM 62, 64, 65, 76, 159
- Navigator LM HV 62, 64, 65, 76, 159
- Navigator LM Radio 62, 68, 69, 76, 94, 95, 159

O

- Operating rods 152, 155
- Opto F 3.0 12, 14, 22, 23, 49, 56, 57, 158
- Opto F+E 3.0 13, 16, 30, 31, 49, 51, 56, 57, 158
- Orion 3.1 114, 115, 137, 160
- Orion M1 114, 115, 137, 160
- Overhead faulted circuit indicators
 - Accessories 76
 - Product matrix 62

P

- PG II 119, 132, 133, 136, 137
- Phase comparators 119, 130, 132, 137
- Phase current transformers 48
- Product matrix
 - Capacitive and resistive voltage signal 52
 - Directional fault indicators 18
 - Directional fault indicators with monitoring 19
 - Earth fault indicators 15
 - Overhead faulted circuit indicators 62
 - Phase comparators 119
 - Remote monitoring 78
 - Short-circuit and earth fault indicators 16
 - Short-circuit indicators 14
 - Smart overhead faulted circuit indicators 63
 - Voltage detecting systems (VDS) 100
 - Voltage detectors 118
 - Voltage indicating systems for transformers and post insulators 101
- Project planning 41
- PSA interface cable 40, 41, 52, 111

R

- Radio Reporter 2.0 68, 69, 79, 83, 85, 94, 95, 159
- Remote monitoring
 - General information 77
 - Product matrix 78
- Reporter 3.0 78, 83, 85, 86, 87, 159
- Reporter 4.0 45, 47, 78, 83, 85, 88, 89, 159
- Resistive voltage sensors 40, 52, 55
- Rotor indicator 12, 14, 20, 158

S

- Selection scheme 12
- Short-circuit and earth fault indicators
 - Accessories 56
 - General information 10
 - Phase current transformers 48
 - Product matrix 16
 - Selection scheme 12
 - Single-phase current sensors 48, 50

Short-circuit indicators

- Accessories 56
- General information 10
- Product matrix 14
- Selection scheme 12
- Short-circuiting bars 143
- Sigma 2.0 12, 14, 24, 25, 50, 56, 57, 158
- Sigma D 13, 18, 40, 41, 42, 43, 50, 52, 56, 57, 158
- Sigma D+ 13, 18, 40, 41, 42, 43, 50, 51, 52, 56, 57, 158
- Sigma D++ 13, 18, 40, 41, 42, 43, 50, 51, 52, 56, 57, 158
- Sigma F+E 2.0 12, 16, 34, 35, 50, 56, 57, 158
- Sigma F+E 3 2.0 12, 16, 34, 35, 50, 56, 57, 158
- Sigma plus 16, 32, 33, 48, 49, 51, 56, 57, 158
- Single-phase current sensors 40, 41, 50
- Smart Navigator 63, 70, 71, 76, 96, 97, 159
- Smart Navigator 2.0 63, 74, 75, 76, 83, 85, 159
- Smart Navigator DFCI HV 63, 72, 73, 76, 96, 97, 159
- Smart Navigator HV 63, 70, 71, 76, 96, 97, 159
- Smart Reporter 71, 73, 79, 96, 97, 160
- Summation current sensors 51
- Summation current transformers 51

T

- Temperature sensor 39, 47, 57
- TP-I 121, 136, 137, 155
- Trip Flag 50, 56, 57, 60, 158

V

- Voltage detecting systems
 - Equipment set options 40
 - General information 99
 - Integrated voltage detecting systems 102, 104, 106, 108, 109
 - Product matrix 100
 - Project planning 41
- Voltage detectors
 - Accessories 136, 155
 - General information 99
 - Product matrix 118
- Voltage sensors
 - Capacitive voltage coupling 54
 - Resistive voltage sensors 55
- Voltage signal 52

W

- Wall holders 155
- Wega 1.2 C 40, 41, 52, 56, 100, 102, 103, 160
- Wega 1.2 C vario 40, 41, 42, 44, 52, 54, 56, 100, 104, 105, 110, 111, 160
- Wega 2.2 C 40, 41, 42, 44, 52, 56, 100, 106, 107, 160
- Wega 3 100, 108, 160
- Wega LRM 100, 109, 160
- Wega T1 101, 112, 160
- Wega T1 vario 54, 56, 101, 113, 160
- Weights 162

Terms of delivery:

All contracts are based on the "General Conditions for the Supply of Products and Services of the Electrical and Electronics Industry" ("Grüne Lieferbedingungen" – GL) of the ZVEI in its relevant version at a time, as well as on the following special conditions:

1. Price settings

All prices are valid for delivery "Ex works Heiligenhaus (or Körperich)" (EXW Heiligenhaus (or Körperich) Incoterms 2010), excluding packing.

2. Metal surcharges

Prices for products made of copper (or partially made of copper) are based on the German "DEL-Notiz (hoch)" at Euro 153.40 per 100 kg, for products made of brass (or partially made of brass) at Euro 143.15 per 100 kg (MS63). Corresponding metal surcharge valid on day of order receipt will be charged additionally to product price.

3. Minimum order value

The minimum order value is Euro 50.00 net. Orders lower than Euro 50.00 net will not be accepted for cost-effectiveness reasons.

4. Handling charges

A handling charge of Euro 13.00 will be charged for orders with order values between Euro 50.00 and Euro 250.00 net.

Product range:

Please note: In both our catalogues and the corresponding price lists you will only find a selection of our product range. In addition, a large number of customer-specific solutions and configurations are possible – please contact us if you cannot find the product you are looking for!

Catalogues/leaflets/instructions for use:

For our customers and interested parties, we also have the current editions of catalogues and leaflets available on our website: <http://www.horstmanngmbh.com>

Exclusively for our customers we also offer the possibility to download the latest instructions for use of all current devices as PDF files via a password-protected access.

If you need further, special documents or have any questions, please do not hesitate to contact us.

We will be glad to help you!