

LVS-9580

Durable, portable handheld verifier



Weighs only 16.7 oz.
(.47 kg)

Portable Barcode Verification System

The LVS-9580 is a high-performance handheld solution for offline barcode verification to ISO/IEC, GS1, and UDI standards. Featuring a high-resolution 5.0 megapixel camera, the LVS-9580 reads and analyzes linear (1D) and two-dimensional (2D) codes up to 76.19 mm (3.0 in.) wide and up to 57.15 mm (2.25 in.) tall. 1D and 2D direct part marks (DPM) of up to 44 mm x 44 mm (1.75" x 1.75") can be verified to MIL-STD-130, ISO, and GS1 standards.

The LVS-9580 verifies multiple symbologies, including any combination of linear, 2D (Data Matrix, QR Code, and Aztec Code), and stacked linear (PDF417, MicroPDF, and Composite codes).

Powered by a 2.0 m (6.5-foot) USB 2.0 cable, the LVS-9580 verifies barcodes on a wide range of surfaces including plastics, PCBs, metal, cardboard, and shipping containers.

LVS-9580: At a Glance

- Stitching feature to grade barcodes larger than the field of view.
- Ideal for multiple line production and warehouse environments.
- Validates printed barcodes to ISO/IEC, GS1, and UDI print quality standards.
- Verifies direct part marks (DPM) to ISO, MIL-STD-130, and GS1 standards.
- High resolution version verifies 2D symbols as small as 2 mil (50 μ) cell size.
- Software upgrade options include Multi-Sector for verification of multiple barcodes on a label.
- 21 CFR Part 11 compliant-ready.
- Supports 15 languages with the ability to add more.
- Quality data reporting for auditing purposes.
- Includes NIST-Traceable Calibrated Conformance Standard Test Card for system calibration.
- Optional adjustable mounting stand adapter.

For more information, visit www.microscan.com.

ISO for 1D

LVS-95XX series barcode verifiers inspect all nine ISO parameters for linear (1D) barcodes, have the ability to identify blemishes, and can perform simple human-readable validation.

ISO for 2D

The LVS-95XX series verifies 2D codes and reports all parameters as specified in the applicable symbology specification.

Analytical Tools

Equipped with numerous analytical tools to identify and evaluate barcode errors. Problems are color-coded to make problem solving easy.

Software

LVS-95XX software includes GS1 System Symbol Specification Tables. GS1 tables set standards for barcode data structure and how to maintain the quality of codes during barcode creation. Omron Microscan offers an online training course on GS1 tables and how these apply to different organizations.

Software Upgrade: EAIV

The Enhanced Application Identifier Verification (EAIV) option verifies that all GS1 Application Identifiers, such as Expiration Date, Global Trade Item Number (GTIN), and Batch Number, embedded in the data structure of a GS1 barcode match the data programmed in the EAIV feature by the user.

User Permission Options

Manage permissions through LVS-95XX software: Passwords are stored in a local database. All passwords are encrypted, include an expiration date, and count failed password attempts.

Manage permissions through Microsoft Active Directory: User privileges are based on Microsoft authentication and LVS-95XX permissions are assigned based on group membership.

Portability

Connects to the latest tablets.

Field of View

- 76 mm (3.0") horizontal
- 57.15 mm (2.25") vertical
- **DPM:** 44 mm (1.75") x 44 mm (1.75")
- **HD:** 33 mm (1.3") x 25 mm (1.0")

LVS-9580: Available Symbologies



Please see the second page for a complete list of supported symbologies.

LVS-9580 SPECIFICATIONS AND OPTIONS

SUPPORTED STANDARDS

Application Standards

AIAG/DAMA/JAPIA/Odette
ISO/IEC TR 29158 (DPM Cat 0, 1, 2)
DHL
FPM AJ
French CIP
GS1 General Specifications
HDMA Guidelines
Health Industry Barcode (HIBC)
Japan Codabar
Laetus Pharmacode
Laetus Standard
MIL-STD-130N
Pharmacy Product Number (PPN)
Automatic GS1 or ISO
GS1 (NTIN)
Miniature Pharmacode
Postal (EIB, USPS IMB/Code 128, POSTNET, Japan Post)
PZN-big, normal, small (German Pharmacode)

GS1 US Certification

Data Matrix for Healthcare
Data Matrix (ECC 200)
EAN/UPC
EAN/UPC and extended codes
EAN/UPC with CC
GS1 DataBar Omnidirectional
ITF-14
GS1 DataBar-14 with CC (formerly RSS-14 with CC)
UCC/EAN with Supplementals
UCC/EAN-128
UCC/EAN-128 with CC

ISO Conformance Standards

ISO/IEC 15415, 15416, 15418
ISO/IEC 15426-1, 15426-2
ISO/IEC TR 29158 (DPM Cat 0)
All supported ISO/IEC Symbology Specifications

MECHANICAL

Height: 215.9 mm (8.5")
Width: 120.6 mm (4.75")
Depth: 139.7 mm (5.5")
Weight: Unpackaged weight: .47 kg (16.7 oz.)
Shipping weight (includes all cables and other items packaged in shipping box): Approx. 1.51 kg (3 lbs. 5 oz.)

FIELD OF VIEW

Standard: 76.19 mm (3.0") horizontal
57.15 mm (2.25") vertical
DPM: 44 mm (1.75") x 44 mm (1.75")
HD: 33 mm (1.3") x 30 mm (1.0")

MINIMUM BAR CODE X-DIMENSION

1D = 4.0 mil (0.10 mm)
2D = 5.9 mil (0.15 mm)
HD: 2D = 2.0 mil (0.05 mm)

MINIMUM PC REQUIREMENTS

PC supplied by customer.
Windows® 7 Professional, Windows® 8.1 Pro, or Windows® 10 Pro;
Intel® Core™ i3 or higher;
4 GB RAM;
800 x 600 Screen Resolution;
One USB 2.0 port available per unit.

SUPPORTED SYMBOLOGIES

Linear (1D) Symbologies

Codabar
Code 128, Code 39, Code 93
DataBar
DataBar Expanded and Limited
DataBar Omnidirectional
DataBar Stacked and Truncated
EAN/JAN-13
EAN/JAN-8
Enterprise Intelligent Barcode (EIB)
4-State (4SB)
GS1-128
HIBC
Interleaved 2 of 5 (ITF)
ITF-14
Japan Post
MSI Plessey
Pharmacode-Italian and Laetus
PZN 7 and PZN 8
UPC-A and UPC-E
USPS-128
USPS Intelligent Mail Barcode (4-State Customer Barcode)

Two-Dimensional (2D) Symbologies

Aztec
DataBar with CC-A, CC-B, or CC-C
EAN/JAN-13 with CC-A, CC-B, or CC-C
EAN/JAN-8 with CC-A, CC-B, or CC-C
ECC-200 (Data Matrix) including:
• EIB CMDM
• French CIP
• GS1 Data Matrix
• NTIN and PPN
GS1-128 with CC-A, CC-B, or CC-C
MaxiCode
Micro QR Code
MicroPDF417
PDF417
QR Code
UPC-A with CC-A, CC-B, or CC-C
UPC-E with CC-A, CC-B, or CC-C
Note: CC = Composite Components
Contact Omron Microscan for a complete list of supported ECC-200 (Data Matrix) codes.

ILLUMINATION

Type: Red filter (660nm)

ELECTRICAL

USB powered 5 VDC @ 180 mA

COMMUNICATIONS

USB 2.0 A plug to Mini-B plug cable
2 m (6.5 ft.)

CAMERA

5.0 megapixel camera
Object Distance: Contact

ENVIRONMENTAL

Operating Temperature: 4° to 46° C
(40° to 115° F)
Relative Humidity, Operating: 20% to 80%
(non-condensing); Relative Humidity,
Storage: 20% to 95% (non-condensing)

21 CFR PART 11

The LVS-9580 is certified by GS1 US and is 21 CFR Part 11 compliant-ready.

CALIBRATION

Calibrated Conformance Test Card
(included with system)

OPTIONS



LVS-9580/9585 Mounting Stand Adapter Bracket Part Number 98-9000200-01

This adapter bracket is designed for use with an Amscope model BSS-140 stand. Together with the BSS-140, the assembly allows the verifier to be held in a fixed position, raised to a 368 mm maximum height and 495 mm horizontal adjustment. The verifier can be rotated a full 360 degrees while mounted, allowing for alignment against the DPM symbol for a broad variety of parts.

Dimensions: 711 mm (28") Width x 406 mm (16") Height x 254 mm (10") Depth
Weight: 14.5 kg (32 lb.)

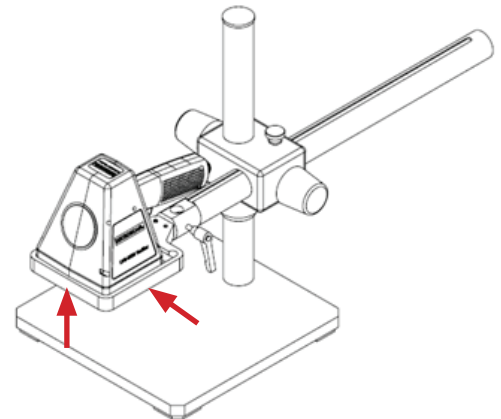

SAFETY CERTIFICATIONS DESIGNED FOR

FCC, CE, UL

RoHS COMPLIANT

QMS CERTIFICATION

www.microscan.com/quality

©2018 Omron Microscan Systems, Inc. SP098C-EN-0518

Warranty – For current warranty information about this product, please visit www.microscan.com/warranty.



OMRON

MICROSCAN

www.microscan.com